



**THS710A, THS720A,
THS730A & THS720P
TekScope™
User Manual**

070-9731-03

This document applies to serial number B010100
and above and firmware version 1.00 and above.

First printing: December 1996



Copyright © Tektronix, Inc. All rights reserved.

Tektronix products are covered by U.S. and foreign patents, issued and pending. Information in this publication supercedes that in all previously published material. Specifications and price change privileges reserved.

Printed in the U.S.A.

Tektronix, Inc., P.O. Box 1000, Wilsonville, OR 97070-1000

TEKTRONIX and TEK are registered trademarks of Tektronix, Inc.

Tek Secure is a registered trademark of Tektronix, Inc.

TekTools, TekScope, and IsolatedChannel are trademarks of Tektronix, Inc.

WARRANTY

Tektronix warrants that the products that it manufactures and sells will be free from defects in materials and workmanship for a period of three (3) years from the date of purchase from an authorized Tektronix distributor. If any such product proves defective during this warranty period, Tektronix, at its option, either will repair the defective product without charge for parts and labor, or will provide a replacement in exchange for the defective product. Batteries are excluded from this warranty.

In order to obtain service under this warranty, Customer must notify Tektronix of the defect before the expiration of the warranty period and make suitable arrangements for the performance of service. Customer shall be responsible for packaging and shipping the defective product to the service center designated by Tektronix, shipping charges prepaid, and with a copy of customer proof of purchase. Tektronix shall pay for the return of the product to Customer if the shipment is to a location within the country in which the Tektronix service center is located. Customer shall be responsible for paying all shipping charges, duties, taxes, and any other charges for products returned to any other locations.

This warranty shall not apply to any defect, failure or damage caused by improper use or improper or inadequate maintenance and care. Tektronix shall not be obligated to furnish service under this warranty a) to repair damage resulting from attempts by personnel other than Tektronix representatives to install, repair or service the product; b) to repair damage resulting from improper use or connection to incompatible equipment; c) to repair any damage or malfunction caused by the use of non-Tektronix supplies; or d) to service a product that has been modified or integrated with other products when the effect of such modification or integration increases the time or difficulty of servicing the product.

THIS WARRANTY IS GIVEN BY TEKTRONIX WITH RESPECT TO THE LISTED PRODUCTS IN LIEU OF ANY OTHER WARRANTIES, EXPRESS OR IMPLIED. TEKTRONIX AND ITS VENDORS DISCLAIM ANY IMPLIED WARRANTIES OF MERCHANTABILITY OR FITNESS FOR A PARTICULAR PURPOSE. TEKTRONIX' RESPONSIBILITY TO REPAIR OR REPLACE DEFECTIVE PRODUCTS IS THE SOLE AND EXCLUSIVE REMEDY PROVIDED TO THE CUSTOMER FOR BREACH OF THIS WARRANTY. TEKTRONIX AND ITS VENDORS WILL NOT BE LIABLE FOR ANY INDIRECT, SPECIAL, INCIDENTAL, OR CONSEQUENTIAL DAMAGES IRRESPECTIVE OF WHETHER TEKTRONIX OR THE VENDOR HAS ADVANCE NOTICE OF THE POSSIBILITY OF SUCH DAMAGES.

Service Assurance

If you have not already purchased Service Assurance for this product, you may do so at any time during the product's warranty period. Service Assurance provides Repair Protection and Calibration Services to meet your needs.

Repair Protection extends priority repair services beyond the product's warranty period; you may purchase up to three years of Repair Protection.

Calibration Services provide annual calibration of your product, standards compliance and required audit documentation, recall assurance, and reminder notification of scheduled calibration. Coverage begins upon registration; you may purchase up to five years of Calibration Service.

Service Assurance Advantages

- Priced well below the cost of a single repair or calibration
- Avoid delays for service by eliminating the need for separate purchase authorizations from your company
- Eliminates unexpected service expenses

For Information and Ordering

For more information or to order Service Assurance, contact your local Tektronix representative and provide the information below. Service Assurance may not be available in locations outside the United States of America.

| | |
|--------------------------|--|
| Name | VISA or Master Card expiration date or |
| Company | purchase order number |
| Address | Repair Protection (1,2 or 3 years) |
| City, State, Postal code | Calibration Service (1,2,3,4 or 5 years) |
| Country | Instrument model and serial number |
| Phone | Instrument purchase date |

To learn the location of your nearest Tektronix representative, please call 1-800-TEK-WIDE in North America, 1-503-627-7111 elsewhere, or look us up on the World Wide Web at <http://www.tek.com>.



Table of Contents

| | |
|-------------------------------------|------------|
| General Safety Summary | iii |
| Preface | v |
| In This Manual | v |
| Conventions | vi |

Getting Started

| | |
|----------------------------------|-----|
| Product Description | 1-1 |
| Replacing the Battery Pack | 1-5 |
| Using External Power | 1-7 |
| Using the Tilt Stand | 1-8 |
| Functional Check | 1-9 |

Operating Basics

| | |
|--|-------------|
| Functional Overview | 2-1 |
| Understanding the Front Panel | 2-1 |
| Using Scope Mode | 2-8 |
| Using Meter Mode | 2-9 |
| Compensating the Oscilloscope Probes | 2-10 |
| Compensating the Oscilloscope Signal Path | 2-11 |
| Taking Floating Measurements | 2-12 |
| General-Purpose Application Examples | 2-15 |
| Displaying an Unknown Signal | 2-16 |
| Measuring Resistance | 2-18 |
| Measuring the Frequency of a Clock Signal | 2-20 |
| Measuring Propagation Delay | 2-22 |
| Triggering on a Missing Data Pulse | 2-24 |
| Detecting Narrow Glitches | 2-26 |
| Triggering on a Third Signal | 2-28 |
| Analyzing a Serial Data Communication Link | 2-30 |
| Triggering on a Video Signal | 2-32 |
| Power-Measurement Application Examples | 2-35 |
| Testing a Switching Transistor Drive Circuit | 2-36 |
| Measuring Instantaneous Power Dissipation in a Switching Transistor | 2-38 |

| | |
|--|------|
| Monitoring for Power Surges and Dropouts | 2-40 |
| Detecting a Missing Power Cycle | 2-42 |
| Measuring Harmonic Current (THS720P) | 2-44 |
| Measuring Motor Start-Up Current | 2-46 |
| Triggering at a Specific Motor RPM | 2-48 |
| Triggering on a Motor Drive Waveform (THS720P) | 2-50 |

Reference

| | |
|--|------------|
| Introduction to Reference | 3-1 |
| ACQUIRE | 3-3 |
| AUTORANGE | 3-8 |
| CURSOR | 3-11 |
| DISPLAY/HARMONICS | 3-13 |
| HARD COPY | 3-22 |
| HOLD | 3-26 |
| HORIZONTAL Controls | 3-27 |
| MEAS | 3-31 |
| METER Mode | 3-37 |
| SAVE/RECALL | 3-43 |
| SCOPE Mode | 3-46 |
| TRIGGER Controls | 3-52 |
| UTILITY | 3-60 |
| VERTICAL Controls | 3-66 |

Appendices

| | |
|--|------------|
| Appendix A: Specifications | A-1 |
| Appendix B: Factory Setup | B-1 |
| Appendix C: Accessories | C-1 |
| Appendix D: Performance Verification | D-1 |
| Test Record | D-2 |
| Performance Verification Procedures | D-4 |
| Appendix E: General Care and Cleaning | E-1 |
| General Care | E-1 |
| Cleaning | E-1 |

Glossary and Index



General Safety Summary

Review the following safety precautions to avoid injury and prevent damage to this product or any products connected to it.

Only qualified personnel should perform service procedures.

Injury Precautions

Use Proper Power Cord. To avoid fire hazard, use only the power cord specified for this product.

Avoid Electric Overload. To avoid injury or fire hazard, do not apply potential to any input, including the common inputs, that varies from ground by more than the maximum rating for that input.

Avoid Electric Shock. To avoid injury or loss of life, do not connect or disconnect probes or test leads while they are connected to a voltage source.

Do Not Operate Without Covers. To avoid electric shock or fire hazard, do not operate this product with covers or panels removed.

Do Not Operate in an Explosive Atmosphere. To avoid injury or fire hazard, do not operate this product in an explosive atmosphere.

Product Damage Precautions

Use Proper Power Source. Do not operate this product from a power source that applies more than the voltage specified.

Do Not Operate With Suspected Failures. If you suspect there is damage to this product, have it inspected by qualified service personnel.

Safety Terms and Symbols

Terms in This Manual. These terms may appear in this manual:



WARNING. *Warning statements identify conditions or practices that could result in injury or loss of life.*



CAUTION. *Caution statements identify conditions or practices that could result in damage to this product or other property.*

Terms on the Product. These terms may appear on the product:

DANGER indicates an injury hazard immediately accessible as you read the marking.

WARNING indicates an injury hazard not immediately accessible as you read the marking.

CAUTION indicates a hazard to property including the product.

Symbols on the Product. These symbols may appear on the product:



DANGER
High Voltage



Protective Ground
(Earth) Terminal



ATTENTION
Refer to Manual



Double
Insulated

Certifications and Compliances

CSA Certified AC Adapter. CSA Certification includes the AC adapters appropriate for use in the North America power network. All other AC adapters supplied are approved for the country of use.

Compliances. Consult the product specifications for Overvoltage Category and Safety Class.

Preface

This User Manual describes the capabilities, operation, and applications of the THS710A, THS720A, THS730A, and THS720P TekScope instruments.

In This Manual





The following table shows you where to find information in this manual.

| If you are looking for: | Turn to: |
|--|---|
| Product overview | <i>Product Description</i> on page 1-1 |
| Details about a product feature | <i>Reference</i> on page 3-1 Look up the front-panel button for the feature |
| Application examples | <i>General-Purpose Application Examples</i> on page 2-15 and <i>Power-Measurement Application Examples</i> on page 2-35 |
| Operation instructions | <i>Understanding the Front Panel</i> on page 2-1 |
| Information about battery operation | <i>Changing the Battery Pack</i> on page 1-5 |
| Information about using external power | <i>Using External Power</i> on page 1-7 |
| Information about making a hard copy | <i>HARD COPY</i> on page 3-22 |
| Technical specifications | <i>Specifications</i> appendix on page A-1 |
| Recommended accessories | <i>Accessories</i> appendix on page C-1 |

Conventions

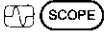
TekScope instrument setups are shown in tables. The *Operating Basics* and *Performance Verification* sections use tables to show specific setups. The *Reference* section uses similar tables to show the complete contents of the menu system.

The header of each table contains icons that represent the controls and menu items used to set up the instrument. To make a specific setup, read the table from left to right and then from top to bottom as shown below. The table contains the symbol “—” if no action is required.

|  METER  SCOPE |  |  |  |  TOGGLE |
|--|---|---|---|--|
| 1. Choose scope mode or meter mode. | 2. Press this button on the front panel. | 3. Press this bezel button. | 4. Press the bezel button again until this selection is highlighted. | 5. Use the +/- rocker to set the value for a parameter. |
| | 6. | 7. | — | |
| | 8. | 9. | 10. | |



Getting Started

Getting Started

In addition to a brief product description, this chapter covers the following topics:

- How to change the battery pack
- How to use external power
- How to use the tilt stand
- How to perform a quick functional check

Product Description

The THS710A, THS720A, THS730A, and THS720P TekScope instruments combine a two-channel oscilloscope and a digital multimeter (DMM) in a rugged, handheld package.

General Features

- Battery power or external power
- High-resolution, high-contrast display with temperature compensation for clear visibility over a wide temperature range
- Onboard waveform, data, and setup storage
- RS-232 communication port to load setups, download waveforms, and make hard copies
- Fully programmable through the RS-232 communication port



Oscilloscope Features

The TekScope instrument is a powerful, two-channel oscilloscope with the following features:

- Autoranging for quick setup and hands-free operation
- 200 MHz (THS730A), 100 MHz (THS720A and THS720P) or 60 MHz (THS710A) bandwidth with selectable 20 MHz bandwidth limit
- 1 GS/s (THS730A), 500 MS/s (THS720A and THS720P), or 250 MS/s (THS710A) sample rate and 2,500 point record length
- Separate digitizers for each channel (both channels always acquire simultaneously)
- Waveform averaging and enveloping with hardware peak detection
- Digital Real Time digitizing (up to five-times oversampling), sin(x)/x interpolation, and peak-detect acquisition to limit the possibility of aliasing
- Independently isolated channels to allow improved safety for measurements to 1000 V_{RMS} while floating up to 600 V_{RMS} using P5102 probes
- Cursors and 21 continuously updated, automatic measurements
- Simultaneous oscilloscope and meter operation on the same or on separate signals
- Advanced pulse, video, external, and motor trigger (THS720P) capabilities
- Harmonic analysis and power measurements (THS720P)



Meter Features

The TekScope instrument is also a full-featured DMM with the following features:

- True RMS VAC, VDC, Ω , continuity, and diode-check functions
- Autoranging or manual ranging
- Data logger plot of meter measurements over a period of time
- Max, min, delta max-min, relative-delta, and average statistics in the readout
- Bar graph for an “analog meter” feel
- Independently isolated meter inputs allow floating measurements to 600 VRMS
- Overvoltage indicator warns when an overvoltage is applied to the input

Input and Output Connectors

All input and output connectors are located on the top and side panels as shown below. See the back of the instrument for maximum voltage ratings.



WARNING. To avoid shock hazard, the DC input and I/O port hole plugs must remain closed in wet or damp conditions.

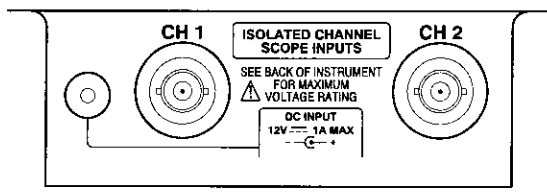

Top panel

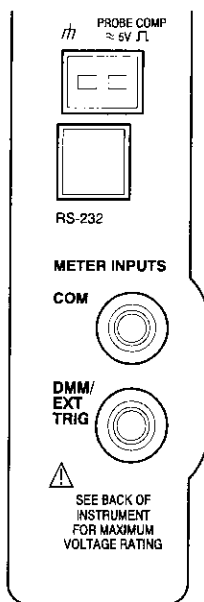
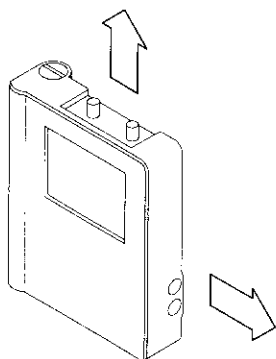

Side panel

Replacing the Battery Pack

For portable operation, use the rechargeable battery pack.

You can replace the battery pack without losing any saved information. The current setup, saved setups, saved waveforms, and saved data are all stored in nonvolatile memory that does not depend on battery power. To prevent loss of saved information, set the ON/STBY switch to STBY before removing the battery pack.



WARNING. To avoid shock hazard, the battery door must remain closed in wet or damp conditions.

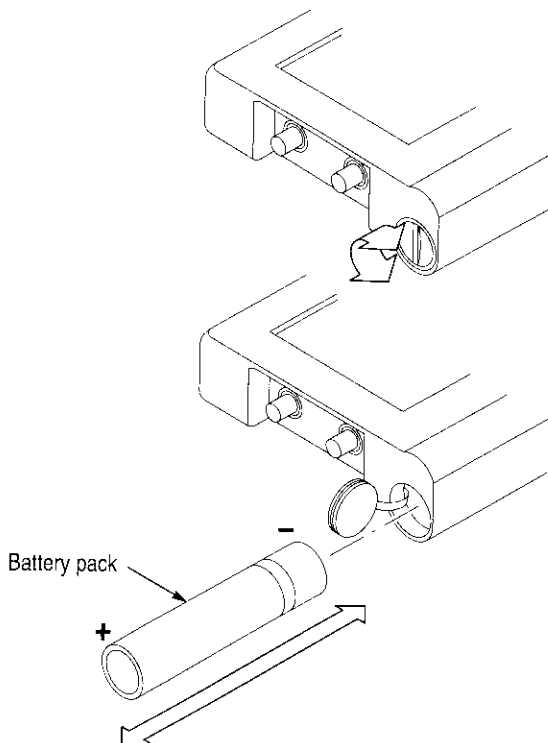

Battery Life

From a full charge, you can operate the TekScope instrument continuously for approximately two hours. You can extend the battery life by using automatic Power Off Time-out or Backlight Time-out. Refer to page 3–63 for a description of these features.

The TekScope instrument turns off automatically when the battery runs low. A low-battery message appears in the display about ten minutes before the automatic shutdown.

Nickel-cadmium batteries can lose capacity permanently if not allowed to discharge completely. Whenever possible, allow the battery to discharge completely before you recharge it to minimize this capacity loss.

Charging the Battery Pack

You can use external power to charge the battery pack while it is in the TekScope instrument. Or you can charge the battery pack with the optional external battery charger.

NOTE. *Before using the battery for the first time, it must be charged.*

Typical battery charging times are listed below.

| Configuration | Typical Charging Time |
|-------------------------------------|-----------------------|
| Battery pack in TekScope instrument | 9 hours |
| Battery pack in external charger | 1.5 hours |



CAUTION. *To avoid loss of saved information when a battery pack is not installed, set the ON/STBY control to STBY before disconnecting external power.*

Using External Power

Using external power from the AC adapter or cigarette lighter adapter has the following advantages:

- Saves internal battery power for portable operation later
- Charges internal battery pack
- Allows extended operation: the Standby Time-out and Backlight Time-out features are automatically disabled when external power is used
- Maintains floating measurement capability of the oscilloscope channels and DMM

Attach the external power source as shown below.

The DC INPUT disconnects itself if an overvoltage is applied. If this occurs, disconnect and then reconnect the AC adapter or cigarette lighter adapter to resume operation from external power.

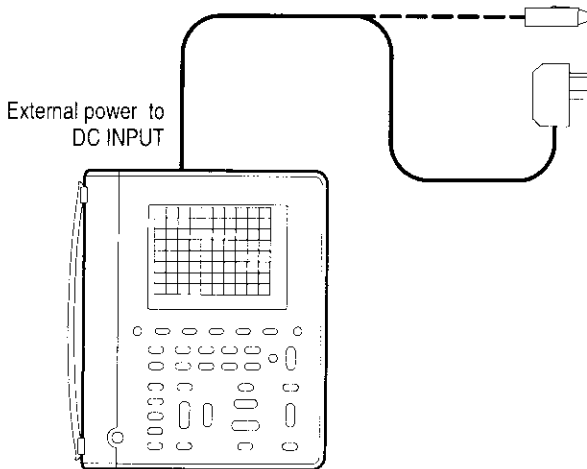

CAUTION. To avoid overheating, do not connect external power while the instrument is in a confined space, such as in the soft case.

Using the Tilt Stand

A built-in tilt stand folds out and snaps back into place when not in use. For benchtop use, lock the tilt stand in place with the hinged flap. To hang the TekScope instrument over a nail, rotate the tilt stand 180°. You can also extend the hinged flap as shown to hang the instrument from a ladder rung or over the top of a door.

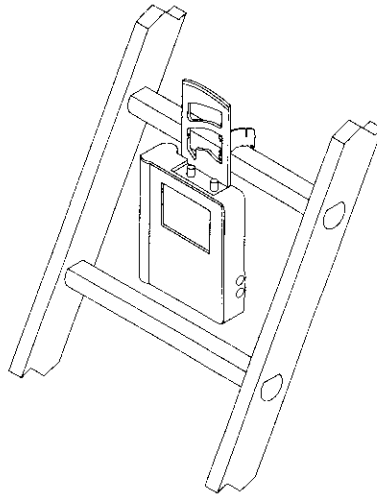
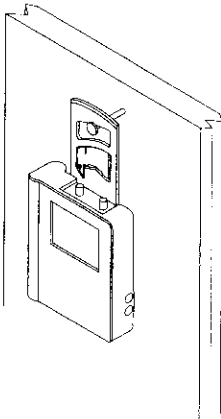
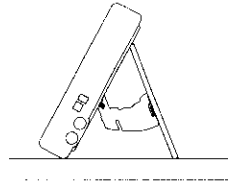
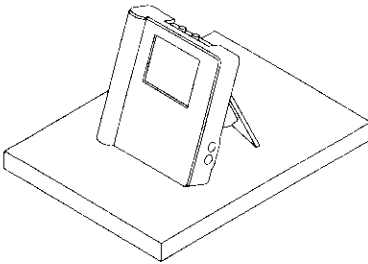

Functional Check

After you install batteries or connect external power, you can perform this quick functional check to verify that your TekScope instrument is operating correctly.

1. Press the **ON/STBY** button to turn on the TekScope instrument.
2. After a few seconds, you should see a window with the message Power-On self check PASSED. Press the **CLEAR MENU** button.
3. Press the **SCOPE** button.
4. Connect the oscilloscope probe to the channel 1 input BNC. Attach the probe tip and reference lead to the **PROBE COMP** connectors on the right side of the TekScope instrument.

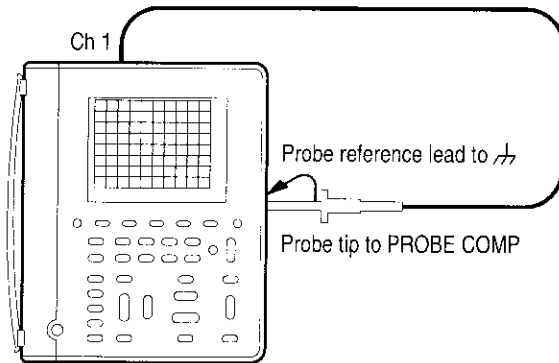

5. Press the **AUTORANGE** button. Within a few seconds, you should see a square wave in the display (approximately 1.2 kHz).
If you want, repeat steps 4 and 5 for channel 2 of the oscilloscope.
6. Press the **METER** button.
7. Press the **VDC** bezel button
8. Press the **AUTORANGE** button.
9. Connect meter leads to the TekScope instrument and touch the meter lead tips to the **PROBE COMP** output as shown below.

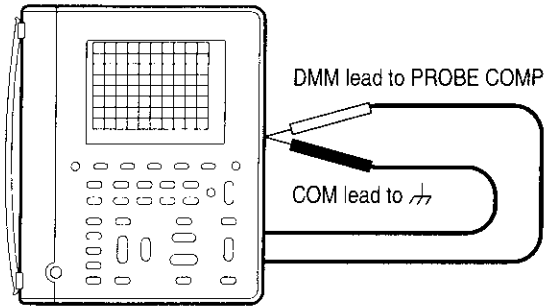

10. Verify that the TekScope instrument measures an average DC voltage of 2.5 ± 0.25 V.



Operating Basics



Functional Overview

This section covers the following topics:

- Understanding the front panel
- Using scope mode
- Using meter mode
- Connecting and using the probes
- Taking floating measurements

You can find specific information about each of the controls in the *Reference* chapter of this manual.

Understanding the Front Panel

The front panel has buttons for the functions you use most often and menus to access more specialized functions. With the autorange feature, you can setup the TekScope instrument automatically in both scope and meter modes.

Using the Menu System

To use the menu system, follow the steps shown on the next two pages.

1. Press a front-panel button to display the menu you want to use.

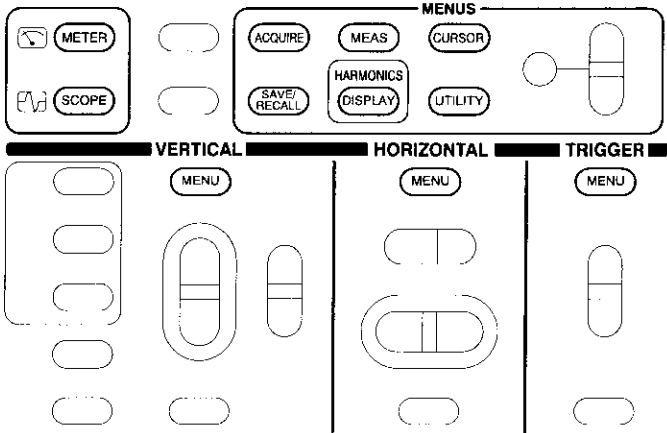

2. Press a bezel button to choose a menu item. If a pop-up menu appears, continue to press the bezel button to choose an item in the pop-up menu. You may need to press the Select Page bezel button to access additional menu items.

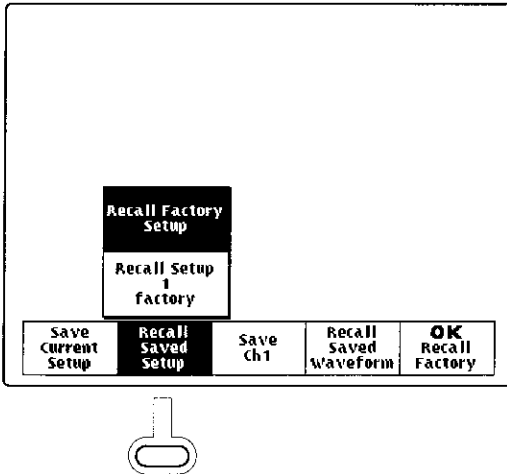

3. Certain menu choices require you to set a numerical parameter to complete the setup. Use the +/- rocker to adjust the parameter value or press the TOGGLE button to reset the parameter to its default value.

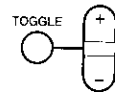
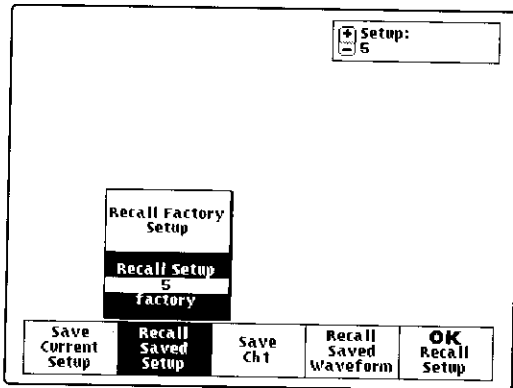

4. If the OK bezel button is displayed, press it to confirm your choice.

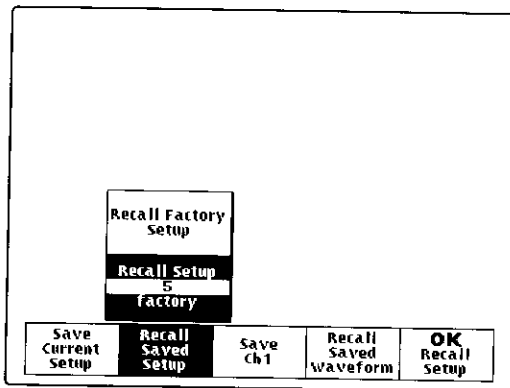

Using the Menu Buttons



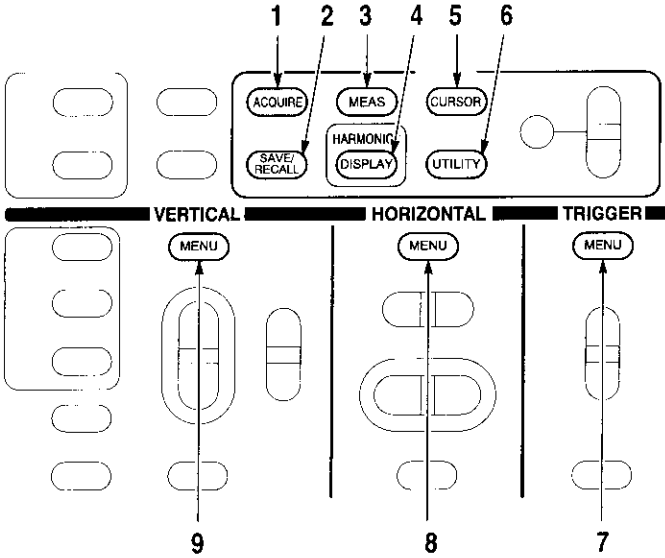



You can use the menu buttons below to perform many functions of the TekScope instrument. Many of these buttons operate differently in scope or meter mode.



1. ACQUIRE.

- Sets acquisition modes.
- Sets calculation mode of data logger.

2. SAVE/RECALL. Saves and recalls setups, waveforms, or DMM data.





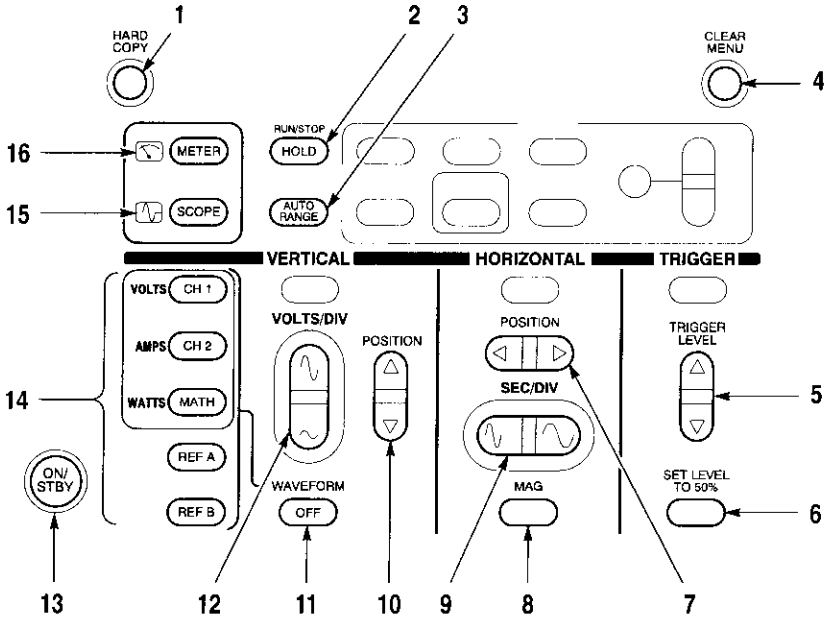

3. **MEASURE.** Performs automated measurements of waveforms or data logger display.
4. **DISPLAY.**
 -  Changes appearance of waveform and display. Activates harmonics (THS720P only).
 -  Changes appearance of data logger display.
5. **CURSOR.** Activates scope or data logger cursors.
6. **UTILITY.** Activates system utility functions.
7. **TRIGGER.**
 -  Activates trigger functions.
8. **HORIZONTAL.**
 -  Changes horizontal characteristics of waveforms.
 -  Adjusts scroll rate of data logger display.
9. **VERTICAL.**
 -  Adjusts scale and position of waveform. Sets input parameters.
 -  Adjusts position of data logger display. Zooms data logger display. Sets volts scale. Changes meter range. Changes vertical scale.

Using the Dedicated Buttons

You can use the dedicated buttons below to take direct actions. These buttons do not require the use of menus.



1. **HARD COPY.** Initiates a hard copy using the RS-232 port.
2. **HOLD.** Stops/restarts oscilloscope acquisition or holds/resets meter readout.
3. **AUTORANGE.** Selects oscilloscope or meter Autorange function.

4. CLEAR MENU. Clears menu from display.
5. TRIGGER LEVEL.  Adjusts trigger level.
6. SET LEVEL TO 50%.  Sets trigger level to midpoint of oscilloscope waveform.
7. HORIZONTAL POSITION.  Adjusts oscilloscope waveform horizontal position.
8. MAG.  Turns 10X horizontal magnification on and off.
9. SEC/DIV. Adjusts horizontal scale factor for oscilloscope or data logger.
10. VERTICAL POSITION. Adjusts vertical position of oscilloscope waveform and DMM data logger display.
11. WAVEFORM OFF.  Removes selected oscilloscope waveform from display.
12. VOLTS/DIV. Adjusts oscilloscope vertical scale factor or meter range.
13. ON/STBY. Selects on or standby. Does not disconnect power from the instrument.
14. CH 1, CH 2, MATH, REF A, REF B.  Displays waveform and chooses selected waveform. In harmonics mode (THS720P), CH 1 and CH 2 also display harmonics of voltage and current waveforms; MATH displays power measurements.
15. SCOPE. Selects scope mode.
16. METER. Selects meter mode.

Using Scope Mode



Press the front-panel SCOPE button to enter scope mode. Then, press AUTORANGE to set the vertical, horizontal, and trigger automatically for a usable display.

The scope-mode display, shown below, is divided into four sections. Refer to *SCOPE Mode* on page 3–46 for a description of each section.

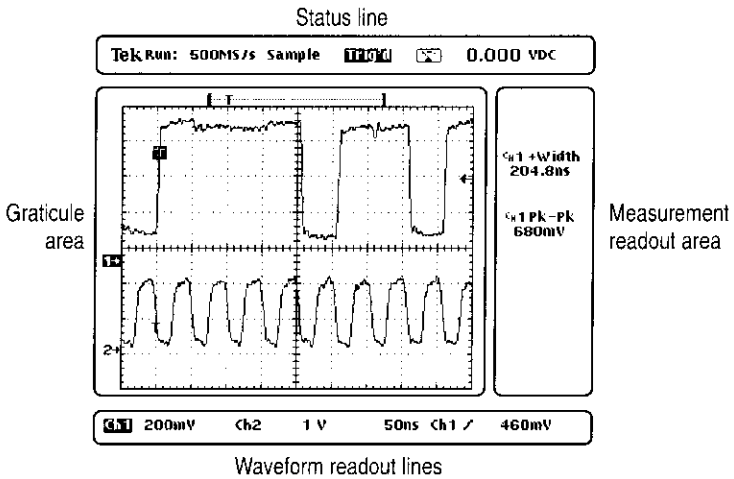

Using Meter Mode



Press the front-panel METER button to enter meter mode. Press one of the bezel buttons to choose a meter function and then press AUTORANGE to set the range automatically.

The meter-mode display, shown below, is divided into three sections. Refer to *METER Mode* on page 3-37 for a description of each section and more information about the data logger and bar graph.

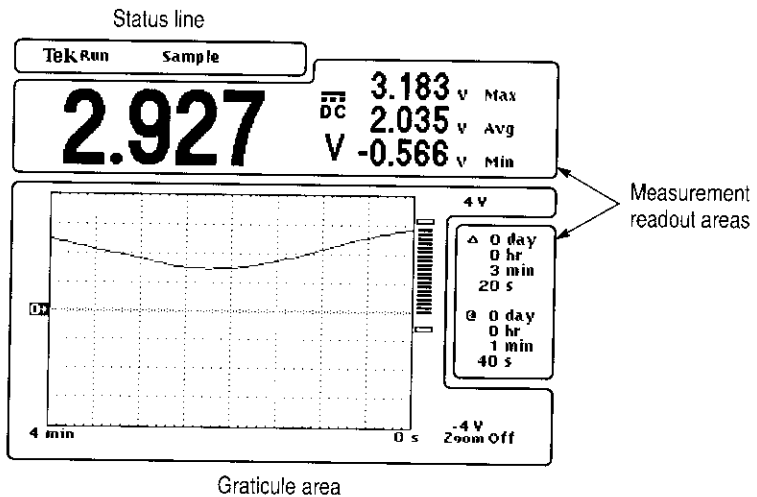

Compensating the Oscilloscope Probes



To maintain signal fidelity, you must compensate each voltage probe for the channel input it is connected to.

1. Connect the oscilloscope probe and then press **AUTORANGE**.

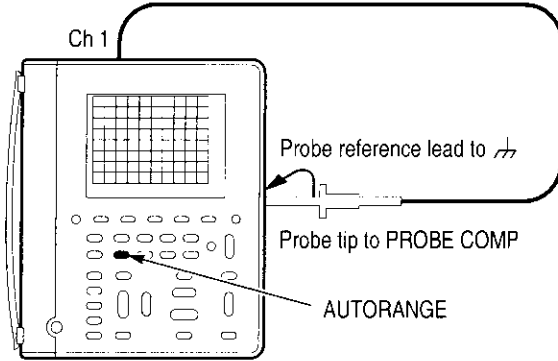

2. Check the shape of the displayed waveform.

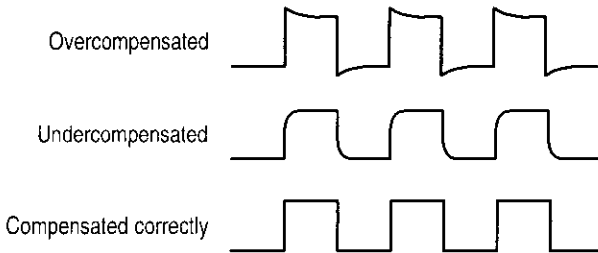

3. If necessary, adjust the probe for correct compensation.

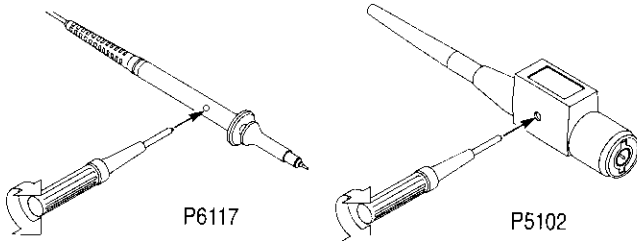

4. Repeat these steps for the other probe and channel.

Compensating the Oscilloscope Signal Path



Signal path compensation optimizes the oscilloscope accuracy for the current ambient temperature. For maximum accuracy, recompensate the signal path if the ambient temperature changes by 5° C or more.

1. Disconnect any probes or cables from the channel 1 and channel 2 input BNC connectors.
2. Press **UTILITY**.
3. Select **CAL** from the System Menu.
4. Press **Signal Path**.
5. Press **OK Compensate Signal Path**. This procedure takes about one minute to complete.

Taking Floating Measurements

This section covers important issues to consider when taking floating measurements.

Architecture is Important

For taking floating measurements, the TekScope instrument has an architectural difference from most other oscilloscopes. The channel 1, channel 2, and DMM inputs are isolated from the main chassis and from each other. This architecture allows independent floating measurements with channel 1, channel 2, and the DMM.

TekScope instrument architecture

Oscilloscope channels and DMM float independently.

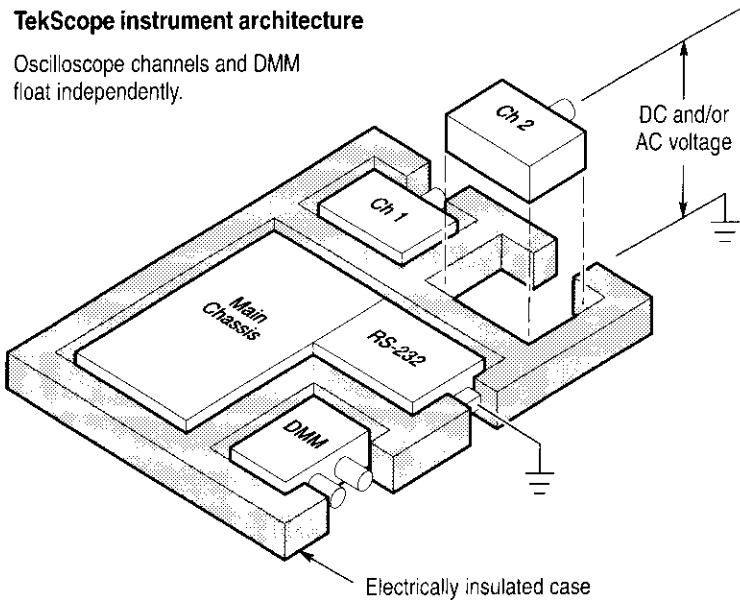

Many handheld oscilloscope/DMM products have the architecture shown below, which shares a common reference for the oscilloscope channels and DMM. With this architecture, all input signals must have the same voltage reference when you take any multi-channel measurements.

Other product architecture

Oscilloscope channels and DMM must float together.

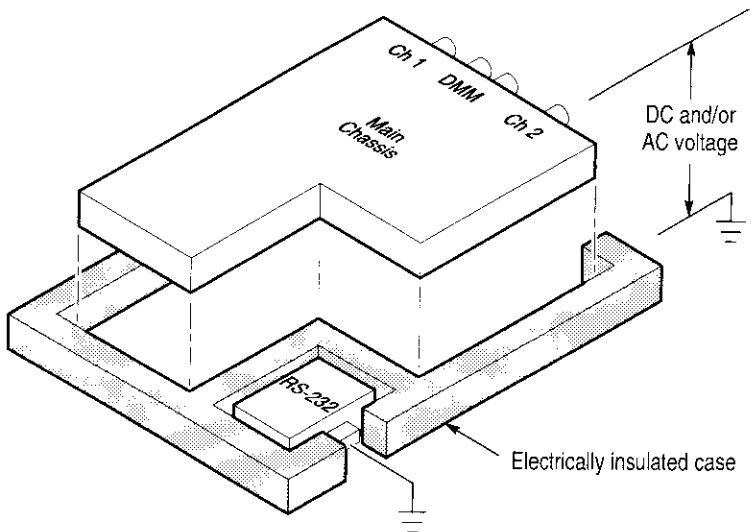

Most bench-top oscilloscopes share the above architecture but without the insulated case. Without differential preamplifiers or external signal isolators, bench-top oscilloscopes are not suitable for taking floating measurements.

Attach the Reference Leads Correctly

If you are using both of the oscilloscope channels, you must attach the probe reference lead for each channel directly to your circuit. These attachments are required because the oscilloscope channels are electrically isolated; they do not share a common chassis connection. Use the shortest possible reference lead with each probe to maintain good signal fidelity. If you are also using the DMM, you must also attach the DMM common lead to your circuit for the same reason as above.

The probe reference lead presents a higher capacitive load to the circuit-under-test than the probe tip. When taking a floating measurement between two nodes of a circuit, attach the probe reference lead to the lowest impedance or least dynamic of the two nodes.

Beware of High Voltages

Understand the voltage ratings for the probes you are using and do not exceed those ratings. Two ratings are important to know and understand:

- The maximum measurement voltage from the probe tip to the probe reference lead
- The maximum floating voltage from the probe reference lead to earth ground

These two voltage ratings depend on the probe and your application. Refer to *Specifications* beginning on page A-1 for more information.



WARNING. *To prevent electrical shock, do not exceed the measurement or floating voltage ratings for the oscilloscope input BNC connector, probe tip, probe reference lead, DMM input connector, or DMM lead.*



General-Purpose Application Examples

This section presents a series of general-purpose application examples. These simplified examples highlight the features of the TekScope instrument and give you ideas about using it to solve your own test problems.

The first two examples demonstrate basic scope and meter operation. The remaining examples provide an overview of applications that cover the following areas:



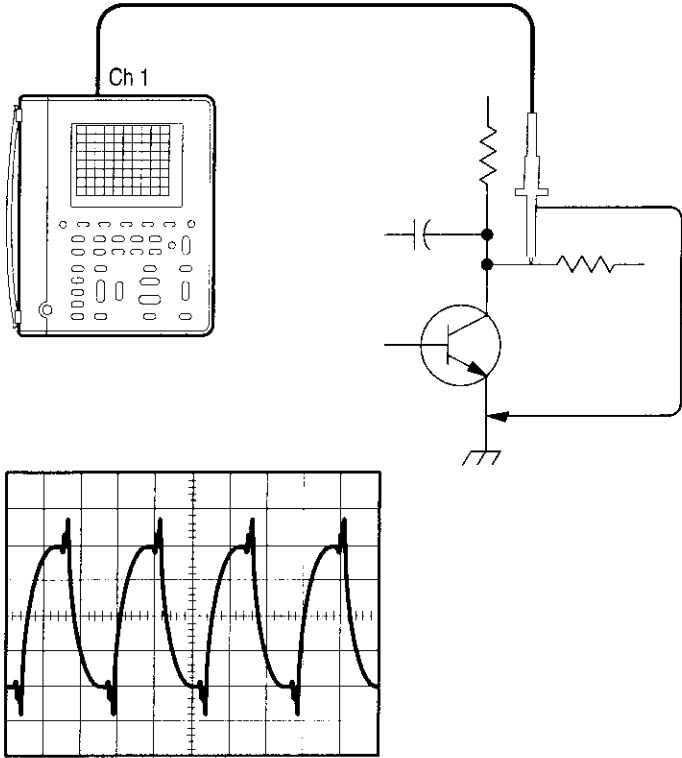

- Digital circuit testing
- Analog circuit testing
- Video signal testing

Displaying an Unknown Signal

You need to see a signal in a circuit, but you have no previous knowledge of the signal amplitude, frequency, or shape. Connect the TekScope instrument to quickly display the signal.



Setup to Display an Unknown Signal

| | | | | |
|---|---|---|---|---|
|  |  |  |  |  |
| SCOPE | AUTO RANGE | — | — | — |

The autorange feature sets the vertical, horizontal, and trigger automatically for a usable display. If the signal changes, the setup tracks those changes.

Going Further

If the autorange setup does not display the waveform exactly the way you like, you can easily change the setup. Press any of the buttons below to cancel autorange mode and modify the setup:

- VOLTS/DIV
- SEC/DIV
- TRIGGER LEVEL
- SET TRIGGER LEVEL TO 50%

Measuring Resistance



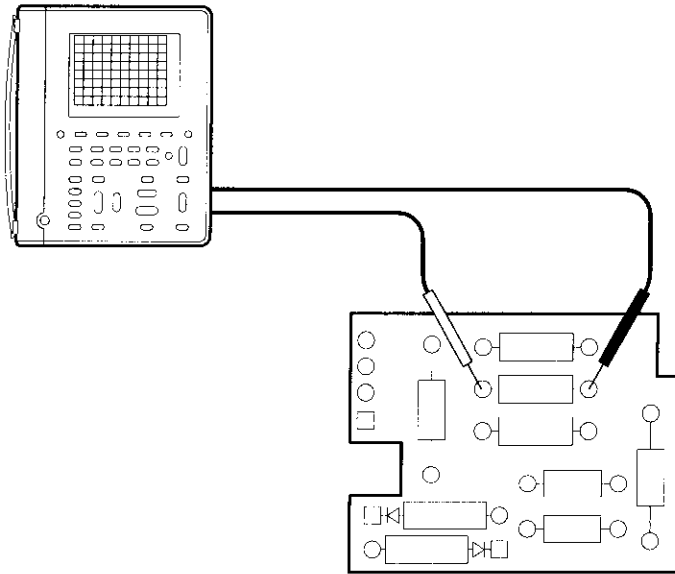

You need to probe a circuit to measure point-to-point resistance. Connect the TekScope instrument to measure a variety of resistance values.

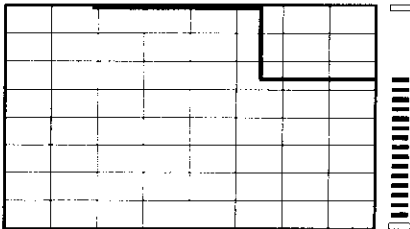

29.23 k Ω







Setup to Measure Resistance

| | | | | |
|---|---|---|---|---|
|  |  |  |  |  |
| METER | AUTO RANGE | Ω | — | — |



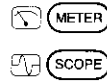

Going Further

If a noisy environment causes an unstable resistance measurement, use the Average statistic to average the measurements. Refer to page 3–35 for more information.

You can use the TekScope instrument as a continuity checker. With the setup below, it beeps when the measured resistance is 50 Ω or less (typical).

| | | | | |
|---|---|---|---|---|
|  |  |  |  |  |
| METER | — |))) (continuity) | — | — |

You can also use the TekScope instrument as a semiconductor-junction checker. Use the setup below to measure the voltage drop across the junction. The open-circuit voltage is limited to about 4 V to prevent damage to reverse-biased junctions.





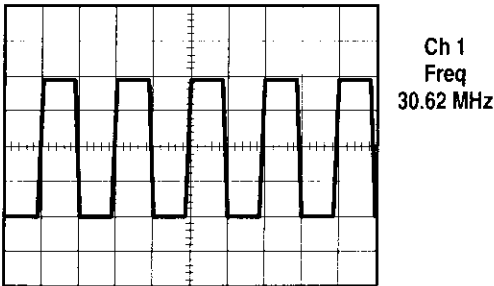
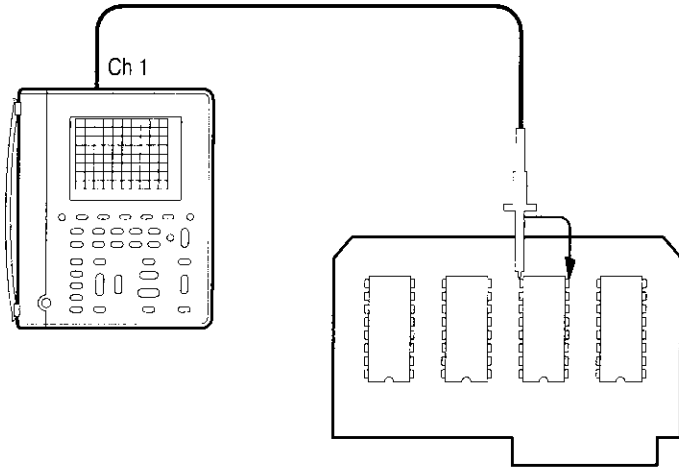

| | | | | |
|---|---|---|---|---|
|  |  |  |  |  |
| METER | — | ∇ (diode) | — | — |

Measuring the Frequency of a Clock Signal

You suspect that the frequency of a TTL clock signal is out of tolerance. Connect the TekScope instrument to the signal to display it and measure its frequency.









Setup to Measure Clock Frequency

|  METER  SCOPE |  |  |  |  |
|--|---|---|---|---|
| SCOPE | AUTO RANGE | — | — | — |
| | MEAS | Select Measmnt for Ch1 | Frequency | |
| | | OK Select Measmnt | — | |

Going Further

You can add peak-to-peak and duty cycle measurements to the display with the following additional steps:



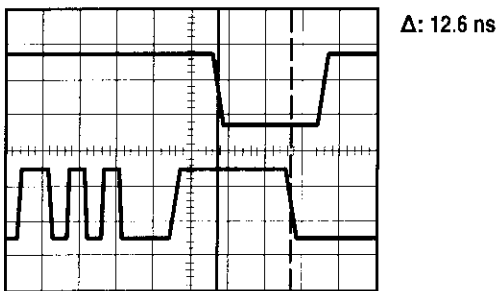
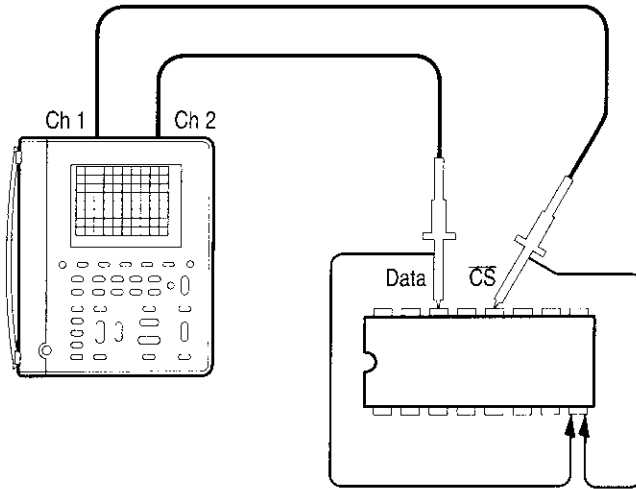

|  METER  SCOPE |  |  |  |  |
|--|---|---|---|---|
| SCOPE | MEAS | Select Page | — | — |
| | | Select Measmnt for Ch1 | Positive Duty Cycle | |
| | | OK Select Measmnt | — | |
| | | Select Page (press once) | — | |
| | | Select Measmnt for Ch1 | Pk-Pk | |
| | | OK Select Measmnt | — | |

Measuring Propagation Delay

You suspect that the memory timing in a microprocessor circuit is marginal. Set up the TekScope instrument to measure the propagation delay between the chip-select signal and the data output of the memory device.



Setup to Measure Propagation Delay

| | | | | |
|---|---|---|---|---|
|  |  |  |  |  |
| SCOPE | CH 1 | — | — | — |
| | CH 2 | | | |
| | AUTO RANGE ¹ | | | |
| | CURSOR | Cursor Function | V Bars | Adjust first cursor, press TOGGLE, and then adjust second cursor |

¹ If necessary, adjust the SEC/DIV rocker to optimize display for the propagation delay measurement.

Set one cursor to the active edge of the chip-select signal and the second cursor to the data output transition. Read the propagation delay in the cursor readout.

Going Further



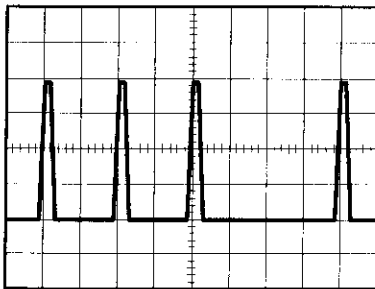
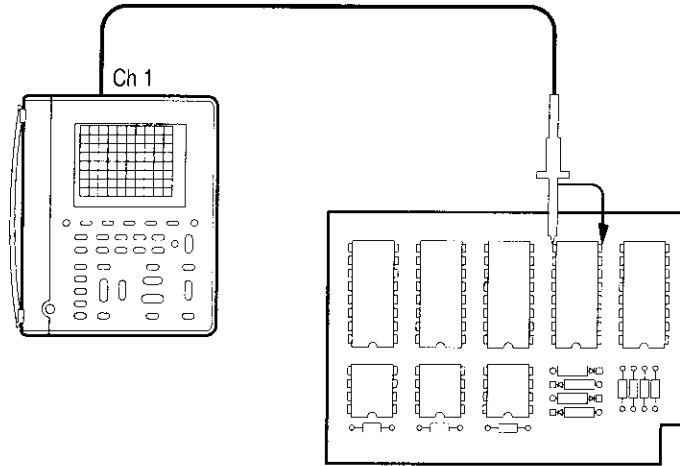

The above example uses cursors to take relative timing measurements (Δ -seconds) between two different waveforms. If you are measuring just one waveform, select the **Paired** cursor function to measure Δ -volts and Δ -seconds at the same time.

Triggering on a Missing Data Pulse

A positive-going TTL data pulse, 20 μ s wide, should occur at least once every millisecond. The circuit is not working correctly and you suspect an occasional missing pulse. Set up the TekScope instrument to find the missing pulse.



Setup to Find Missing Data Pulse

| | | | | |
|---|---|---|---|---|
|  |  |  |  |  |
| SCOPE | AUTO RANGE | — | — | — |
| | TRIGGER MENU | Trigger Type | Pulse | |
| | | Trigger Source | Ch1 | |
| | | Polarity and Width | Negative | <i>Set width to 1 ms</i> |
| | | Trigger When | Greater Than Width | — |
| | | Mode | Normal | |

The TekScope instrument triggers if the signal remains in the low state longer than 1 ms. If it does, you have found an occurrence of a missing pulse.

Going Further

You can extend this application in several ways:





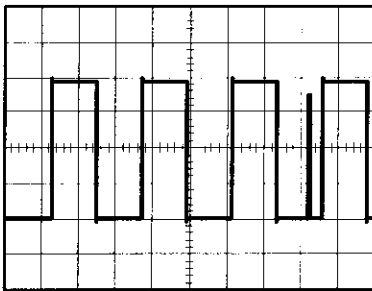
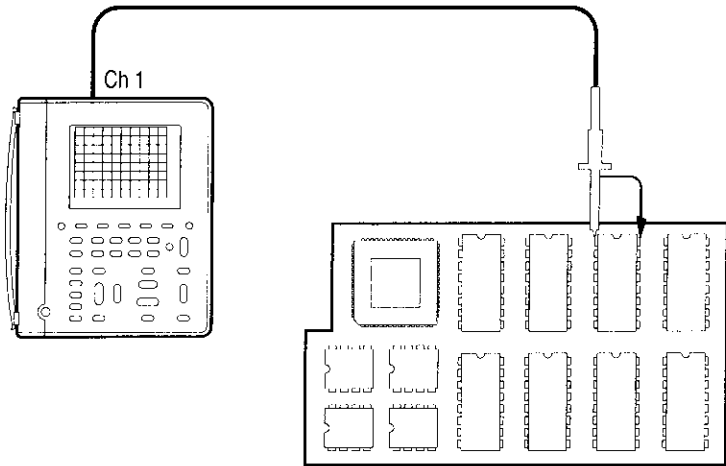

- If the pulses are supposed to be periodic (1 ms period) and you suspect an occasional extra pulse, change the width setting to **980 μs** and the **Trigger When** submenu to **Less Than Width**. With this setup, TekScope instrument triggers if the spacing between the pulses ever drops below 980 μs, which indicates an occurrence of an extra pulse.
- Use the second channel to find the cause of the problem. You can correlate the cause and the effect because the TekScope instrument always acquires both channels at exactly the same time.

Detecting Narrow Glitches

An elapsed-time counter circuit operates from a precision, 1 kHz square wave, clock signal supplied by another source. Occasionally, the counter counts too fast. You suspect glitches in the clock signal are causing the problem. Set up the TekScope instrument to look for glitches in the clock signal.









Setup to Detect Narrow Glitches

| | | | | |
|--|---|---|---|---|
|  METER  SCOPE |  |  |  |  |
| SCOPE | AUTO RANGE | — | — | — |
| | ACQUIRE | Acquire Mode | Envelope | |

Monitor the clock signal for several minutes. In Envelope acquisition mode, the TekScope instrument displays the 1 kHz square wave clock signal plus intermittent glitches that are as narrow as 8 ns.

Going Further

You can trigger on the glitch itself with the following setup:

| | | | | |
|--|---|---|---|---|
|  METER  SCOPE |  |  |  |  |
| SCOPE | TRIGGER MENU | Trigger Type | Pulse | — |
| | | Trigger Source | Ch1 | |
| | | Polarity and Width | Positive | <i>Set width to 500 μs</i> |
| | | Trigger When | Less Than Width | — |
| | | Mode | Normal | |

A trigger occurs only if a positive pulse narrower than 500 μs (half the period of the clock signal) is detected.

Triggering on a Third Signal



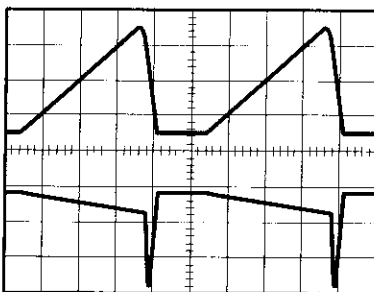
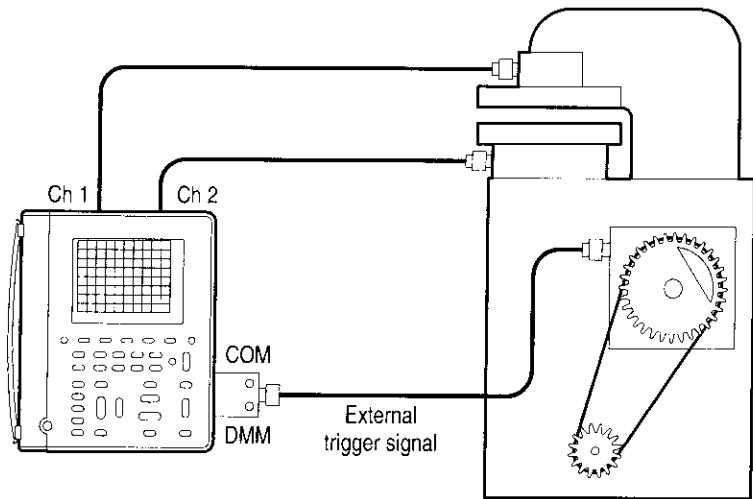

A metal forming machine produces an index pulse for each revolution of its main shaft. Connect the external trigger input of the TekScope instrument to the index pulse so you can monitor the output of two transducers while you vary the operating speed of the machine.



Transducer #1 (Ch 1)

Transducer #2 (Ch 2)

Setup to Use External Trigger

| | | | | |
|---|---|---|---|---|
|  |  |  |  |  |
| SCOPE | TRIGGER MENU | Trigger Type | Edge | — |
| | | Trigger Source | External | |

Connect the index pulse to the meter inputs, which now function as the external trigger input. Adjust the TRIGGER LEVEL rocker for stable triggering on the index pulse signal.

Going Further





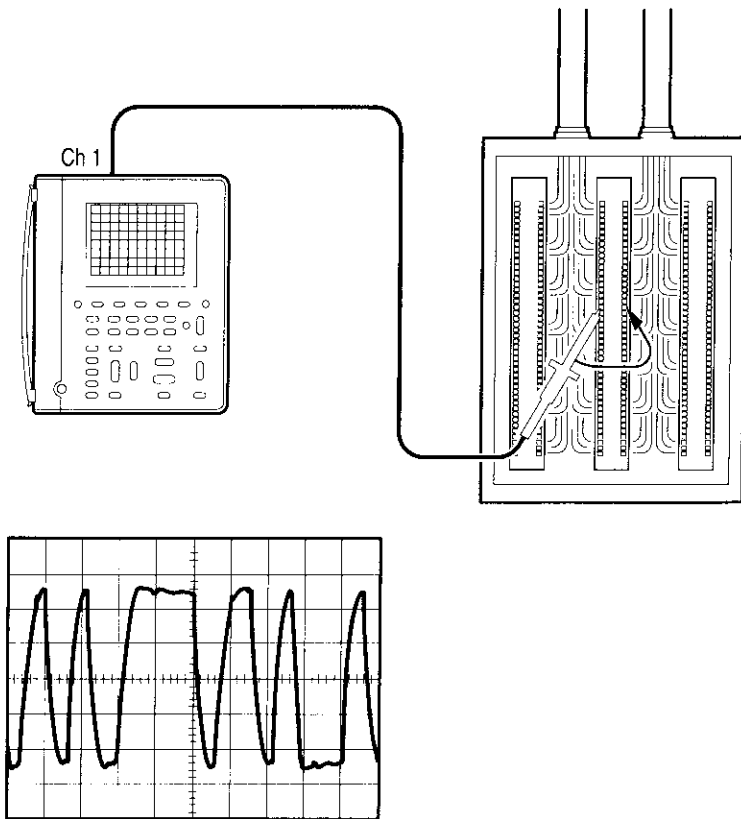

You can use the external trigger input to trigger on a 50 Hz or 60 Hz AC power line. This leaves the two channel inputs free to probe other circuits that are synchronized to the AC power line. Set the external trigger level to 0.2 V to trigger as close as possible to a zero crossing.

Analyzing a Serial Data Communication Link

You are having intermittent problems with a serial data communication link and you suspect poor signal quality. Set up the TekScope instrument to show you a snapshot of the serial data stream so you can verify the signal levels and transition times.



Setup to Capture a Single Shot

|  METER  SCOPE |  |  |  |  |
|--|---|---|---|---|
| SCOPE | AUTO RANGE | — | — | — |
| | ACQUIRE | Stop After | Single Acquisition Sequence | |
| | HOLD (RUN/STOP) | — | — | |

Each time you press the HOLD (RUN/STOP) button, the instrument acquires a snapshot of the digital data stream. You can use the cursors or automatic measurements to analyze the waveform, or you can store the waveform to analyze later.

Going Further



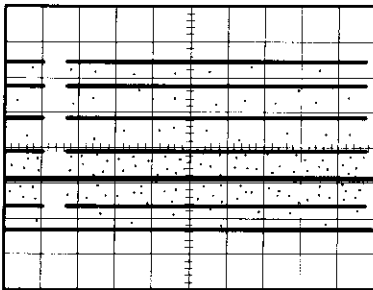
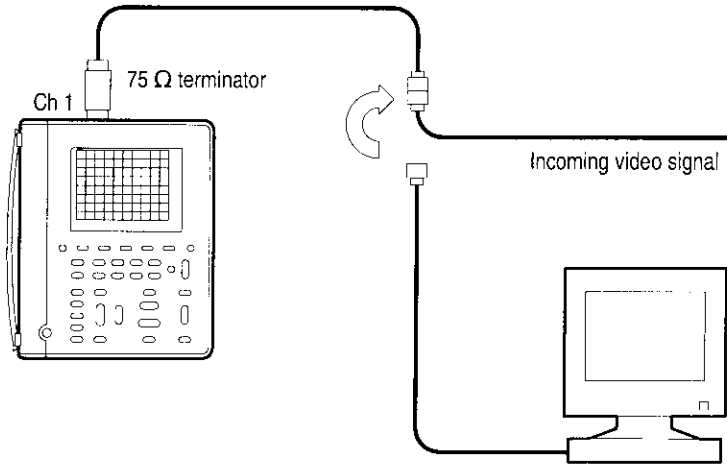

When you capture a single shot using both channels, the two waveforms are always acquired simultaneously. After the acquisition, use the vertical bar cursors to take accurate timing measurements from one waveform to the other.

Triggering on a Video Signal

The image quality is poor on a video monitor in a closed-circuit security system that operates at a 15 kHz scan rate. Set up the TekScope instrument to display and trigger on the odd field of the video waveform coming into the monitor.







Setup to Trigger on the Odd Field

| | | | | |
|---|---|---|---|---|
|  |  |  |  |  |
| SCOPE | VERTICAL MENU | Probe Type | Voltage Probe | <i>Set to 1X</i> |
| | AUTO RANGE | — | — | — |
| | DISPLAY | Display Style | Dot Accumulate | <i>Set to 100 ms</i> |
| | TRIGGER MENU | Trigger Type | Video | — |
| | | Trigger On | Odd Field | — |
| | | Scan Rate | — | <i>Set to 15-20 kHz</i> |

Adjust the **SEC/DIV** rocker to **2 ms/div** to display the odd field across about eight divisions. The Dot Accumulate display style simulates an analog oscilloscope display of the video signal.

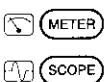
Going Further

Use the following setup to trigger on a specific video line.

| | | | | |
|---|---|---|---|---|
|  |  |  |  |  |
| SCOPE | TRIGGER MENU | Trigger Type | Video | — |
| | | Trigger On | Odd Field | <i>Set line number</i> |

Adjust the **SEC/DIV** rocker to **10 μs/div** to display the line across about six divisions.

Power-Measurement Application Examples

This section presents a series of power-measurement application examples. These simplified examples highlight the features of the TekScope instrument and give you ideas about using it to solve your own test problems.

These examples provide an overview of applications that cover the following areas:

- Power electronics testing
- Power quality testing
- Motor testing





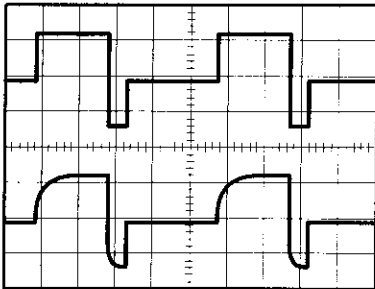
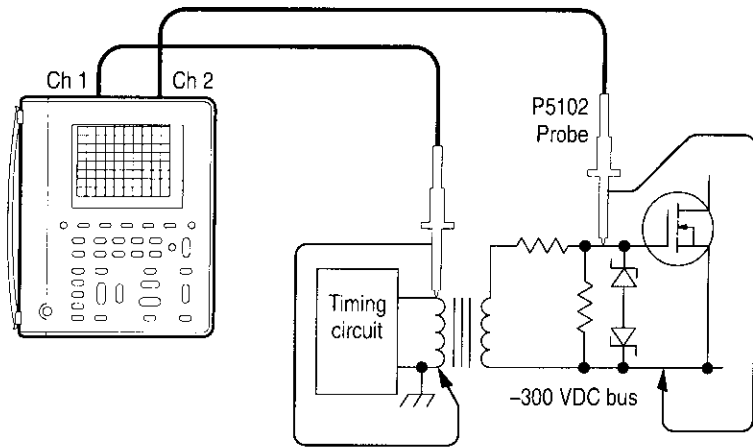

NOTE. *Some of these application examples require optional probes. Others highlight features only available in the THS720P.*

Testing a Switching Transistor Drive Circuit

You need to evaluate the gate-drive circuit for a power FET (field-effect transistor) in a switching power supply. The gate-drive timing circuit is referenced to chassis ground. But the gate-drive signal is transformer-coupled to the FET, which is connected to a -300 VDC bus. Set up the TekScope instrument to compare the gate-drive signal at the output of the timing circuit to the signal at the gate of the FET.



Setup to Test the Transistor Drive Circuit

| | | | | |
|--|---|---|---|---|
|  METER  SCOPE |  |  |  |  |
| SCOPE | CH 1 | — | — | — |
| | CH 2 | | | |
| | AUTO RANGE | | | |

You do not have to do anything special to take this difficult measurement. Because of the isolated channels, you can reference the channel 1 probe to chassis ground and the channel 2 probe directly to the -300 VDC bus. Channel 1 displays the gate-drive signal directly from the driver and channel 2 displays the signal as it is received by the power FET.

Going Further

The isolated channels allow you to reference a channel to AC as well as DC voltages.

- You can connect the P5102 probe reference lead to 50 Hz, 60 Hz, or 400 Hz AC power lines (up to the maximum voltage rating).
- You can connect the P6117 or P5102 probe reference lead to many other dynamic signals (up to the maximum voltage rating).

Because you can connect to references other than ground, you can take many measurements that would otherwise require an oscilloscope with a differential input.

Measuring Instantaneous Power Dissipation in a Switching Transistor

The output transistor in a switching power supply is hotter than it should be. You are concerned about its peak power dissipation. Set up the TekScope instrument to measure the instantaneous power dissipation of the transistor using an optional current probe.

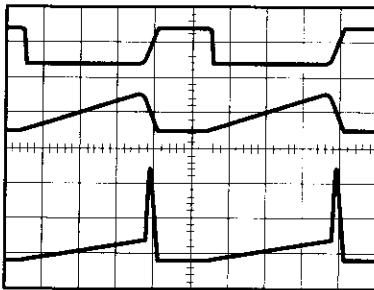
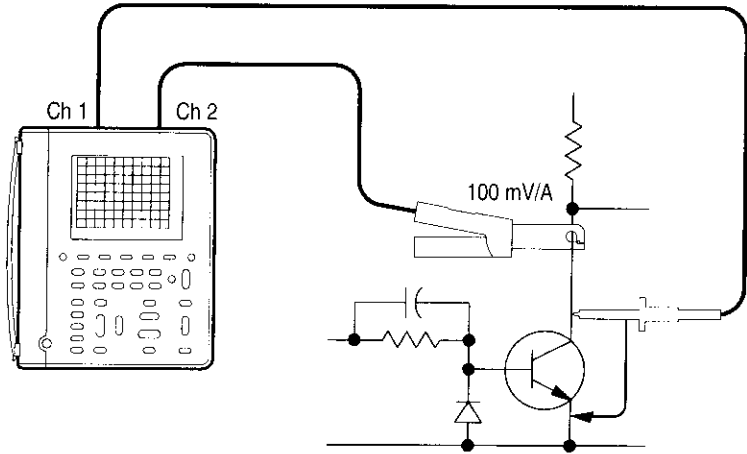





Voltage waveform (Ch 1)

Current waveform (Ch 2)

Power waveform (Math)





Setup to Measure Instantaneous Power Dissipation

| |  |  |  |  |  |
|-------|---|---|---|---|---|
| SCOPE | | — | — | — | — |
| | | Probe Type | Current Probe | | Set to 100 mV/A |
| | | — | — | — | — |
| | | Math Operation | Ch1 × Ch2 | | |
| | | Cursor Function | Paired | | Set cursor |

Move the cursor along the power (MATH) waveform and read the instantaneous power in the cursor readout (for example, @5.63 W).

Going Further

Measure the average power dissipation in the transistor (mean value of the power waveform) with the following setup:

| |  |  |  |  |  |
|-------|--|---|--|--|--|
| SCOPE | | MEAS | Select Measrmt for MATH | Mean | — |
| | | | OK Select Measrmt | — | |





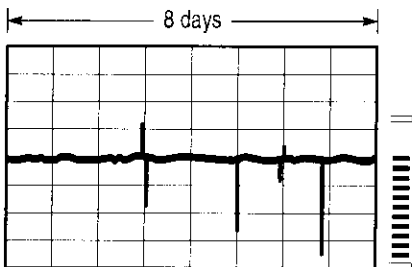
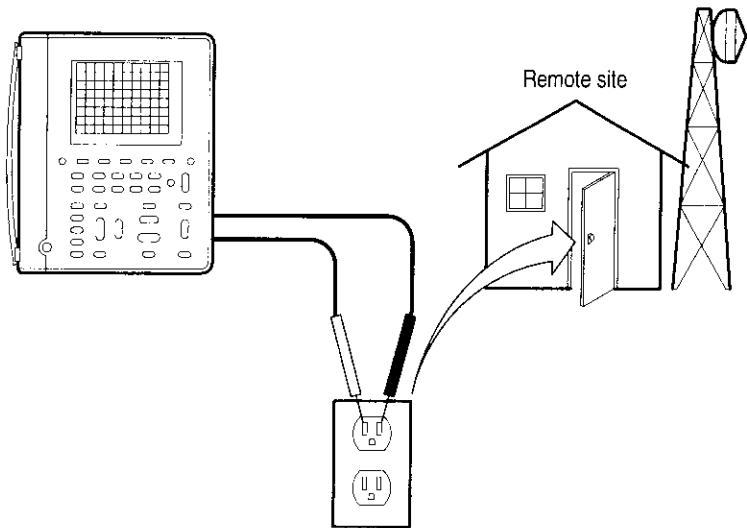

You can also display the I-V characteristic of the transistor for comparison to its safe operating area using the XY display format. Refer to page 3–14 for information on XY display format.

Monitoring for Power Surges and Dropouts

You are having intermittent problems with some electronic equipment that operates unattended at a remote site. You need to determine if the problem might be caused by momentary power quality problems in the electrical service to the equipment. Set up the TekScope instrument to monitor the line voltage for a week and capture any surges or dropouts that may occur.



Setup to Monitor for Power Quality Problems

| | | | | |
|--|---|---|---|---|
|  METER  SCOPE |  |  |  |  |
| METER | — | VAC | — | — |
| | ACQUIRE | Acquire Mode | Peak Detect | |







You can use the DMM data logger to record measurements over an extended period of time. Set the full-scale range to 400 V using the **VOLTS/DIV** rocker. Adjust the **SEC/DIV** rocker so that the data logger horizontal scale is one day per division.

Meter measurements, which occur at a rate of approximately ten per second, are captured over an eight-day period of time.

Going Further

You can position and zoom the data logger plot to see more resolution (refer to page 3–70 for information).

Use the cursors to determine when a power disturbance occurred (to within the nearest 24 minutes).

| | | | | |
|--|--|--|--|--|
|  METER  SCOPE |  |  |  |  |
| SCOPE | CURSOR | Cursor Function | V Bars | Set cursor |



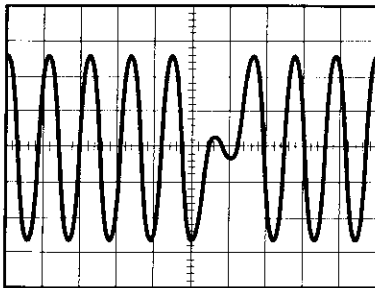
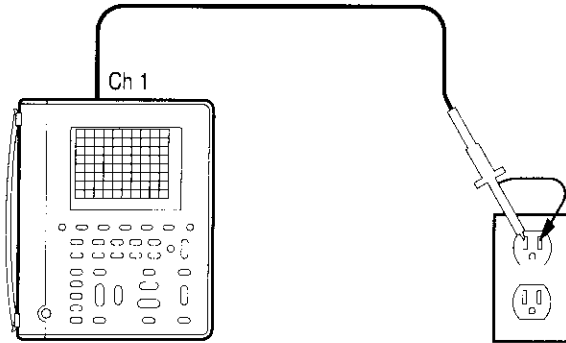

Move either cursor to the location of the power disturbance. Read the relative time in the cursor readout (for example, @ 5 day, 7 hr, 12 min). Calculate the absolute time and date of the disturbance using the current time and this measurement.

Detecting a Missing Power Cycle

You suspect that power distribution switches are causing an infrequent, missing power cycle at the equipment you are servicing. Connect the TekScope instrument to detect a missing cycle on the 60 Hz AC power line.

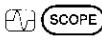

Setup to Detect a Missing Cycle

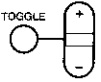
| | | | | |
|--|---|---|---|---|
|  METER  SCOPE |  |  |  |  |
| SCOPE | AUTO RANGE | — | — | — |
| | TRIGGER MENU | Trigger Type | Pulse | |
| | | Trigger Source | Ch1 | |
| | | Polarity and Width | Negative | <i>Set width to 20 ms</i> |
| | | Trigger When | Greater Than Width | — |
| | | Mode | Normal | |

Set the trigger level to +50 V. The TekScope instrument triggers if one or more power cycles drop below a 50 V_{pk} threshold. You can set the voltage threshold to any other level that constitutes a power dropout.

Going Further

Use the other channel to analyze the effect that the missing cycle has on your equipment:

- Momentary sags in internal power-supply voltages
- Malfunctions in digital circuitry
- Variations in clock frequencies





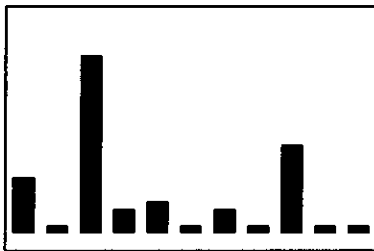
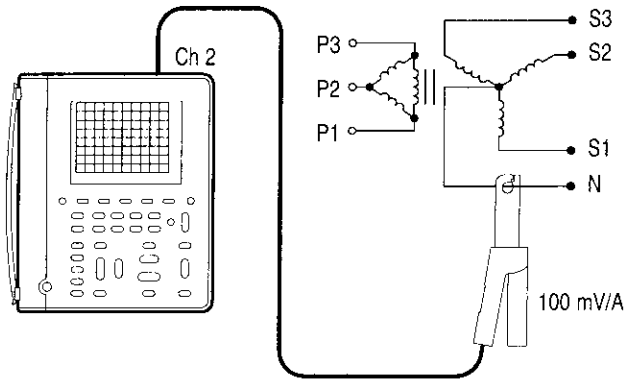

Channel 1 and channel 2 are always acquired simultaneously so you can correlate a cause displayed on one channel to the effect displayed on the other.

Measuring Harmonic Current (THS720P)

A three-phase power distribution system feeds an office that contains a lot of electronic equipment. Connect the TekScope instrument to analyze the harmonic current in the neutral conductor.



Setup to Measure Harmonic Current

| | | | | |
|--|---|---|---|---|
|  METER  SCOPE |  |  |  |  |
| SCOPE | DISPLAY | Harmonics | On | — |
| | | Show | All from | Select F to 11 |
| | | THD Method | THD-F | — |
| | | Probes | Ch 2 Probe | Set to 100 mV/A |

The TekScope instrument shows a bar-graph display of the harmonic current in the neutral conductor. You can verify whether or not the large third harmonic caused by the nonlinear load exceeds the current rating of the neutral conductor.

Going Further

You can also measure harmonic voltage and harmonic power. Press CH 1 to display the voltage harmonics, press CH 2 to display the current harmonics, or press MATH to display the power measurements.

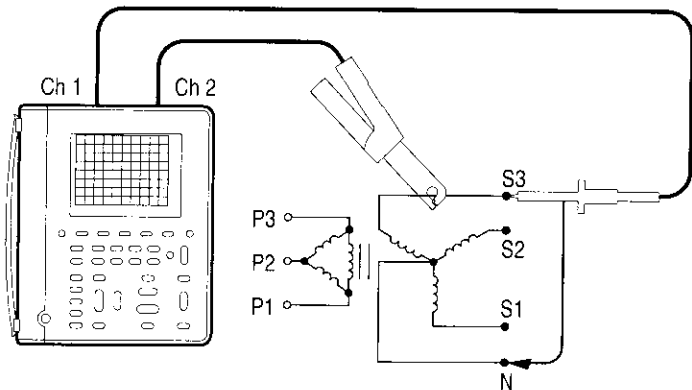



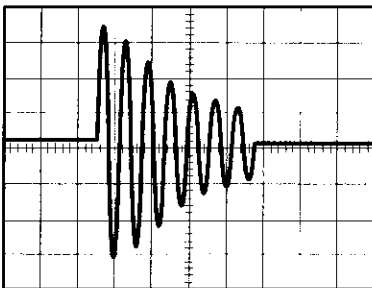
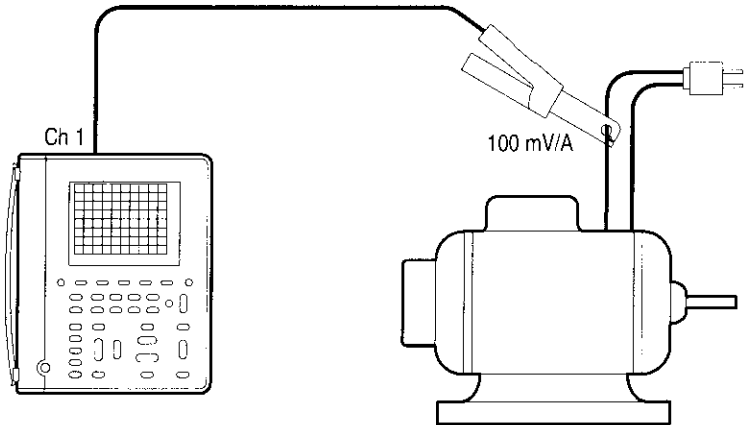

Measuring Motor Start-Up Current

A circuit breaker trips when a motor starts. Connect the TekScope instrument to measure the transient current drawn by the motor before the circuit breaker trips.



Setup to Measure Transient Current

| | | | | |
|---|---|---|---|---|
|  |  |  |  |  |
| SCOPE | CH 1 | Probe Type | Current Probe | Set to 100 mV/A |
| | ACQUIRE | Stop After | Single Acquisition Sequence | — |
| | HOLD (RUN/STOP) | — | — | — |

When you start the motor, the instrument captures the transient current and freezes the waveform in the display.

Going Further

You can measure the true RMS current of the transient current using the following technique:

1. Turn on automated measurements for channel 1 and select the BrstW (burst width) and RMS measurements. Refer to page 3–31 for information about automatic measurements.
2. Record the BrstW and RMS measurements.
3. Record the SEC/DIV setting.
4. Calculate the true RMS value of the transient current using recorded values in the one of the equations below:

$$\text{True RMS} = \text{RMS} \times \sqrt{10 \times \frac{\text{SEC/DIV}}{\text{BrstW}}} \quad (\text{if MAG is off})$$

$$\text{True RMS} = \text{RMS} \times \sqrt{100 \times \frac{\text{SEC/DIV}}{\text{BrstW}}} \quad (\text{if MAG is on})$$

Triggering at a Specific Motor RPM





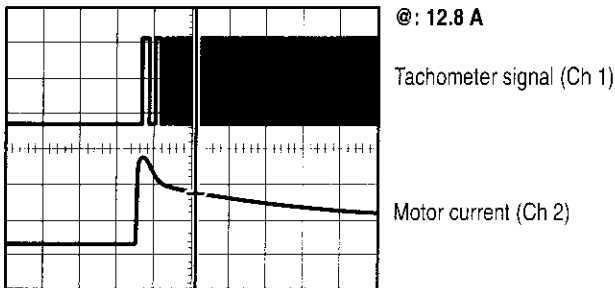
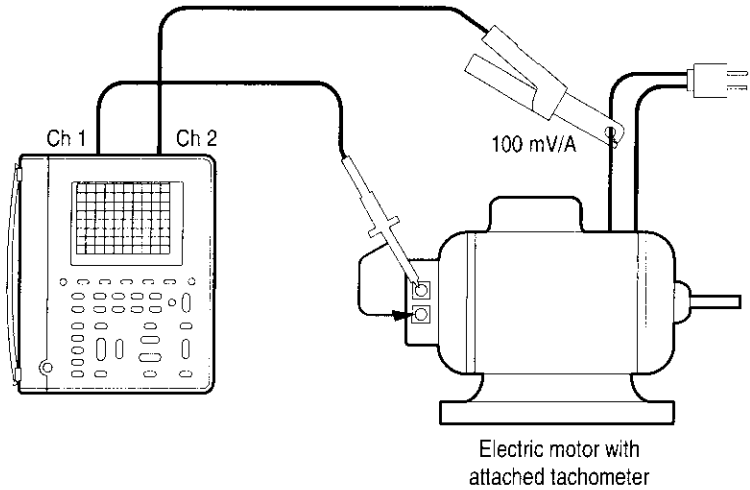

You need to measure the start-up current of a 3600-RPM motor at several specific speeds. A tachometer, attached to the motor, outputs a low-voltage square wave with 100 pulses per revolution. Set up the TekScope instrument to trigger at 1200 RPM so you can measure the current at that speed.

$$\text{Tachometer output frequency} = \frac{1200 \text{ rev/min} \times 100 \text{ pulses/rev}}{60 \text{ s/min}} = 2 \text{ kHz}$$

$$\text{Tachometer pulse width} = \frac{\text{period}}{2} = \frac{1}{2 \text{ kHz}} = 250 \mu\text{s}$$



Setup to Trigger at 1200 RPM

|  METER  SCOPE |  |  |  |  | |
|--|---|---|---|---|--------------------------|
| SCOPE | CH 1 | — | — | — | |
| | CH 2 | Probe Type | Current Probe | Set to 100 mV/A | |
| | HORIZONTAL MENU | Trigger Position | 50% | — | |
| | TRIGGER MENU | Trigger Type | Pulse | | |
| | | Trigger Source | Ch1 | | |
| | | Polarity and Width | Positive | | Set width to 250 μ s |
| | | Trigger When | Equal To Width | | Set \pm 5% |
| | | Mode | Normal | — | |
| CURSOR | Cursor Function | Paired | Set cursor to horizontal center of graticule | | |

Set appropriate **VOLTS/DIV** for each channel. Set **SEC/DIV** so that the sweep duration is approximately equal to the motor start-up time. When the motor starts, the 1200 RPM point is displayed at the center of the graticule. Use the cursor on channel 2 to measure the armature current at this point.

Going Further



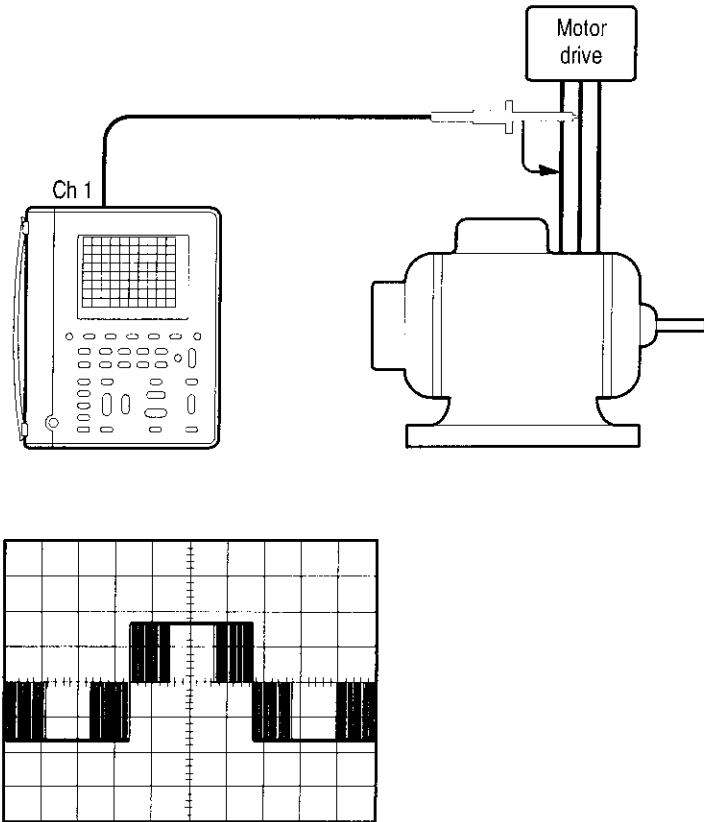

Change the trigger pulse width setting to trigger at other specific motor RPMs to complete the test.

Triggering on a Motor Drive Waveform (THS720P)

You need to analyze the output waveform of a variable-speed AC motor drive. Connect the TekScope instrument to trigger on the output waveform of the motor drive.



Setup to Use Motor Trigger

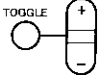



| | | | | |
|--|---|---|---|---|
|  METER  SCOPE |  |  |  |  |
| SCOPE | AUTO RANGE | — | — | — |
| | TRIGGER MENU | Trigger Type | Motor | |

Adjust the TRIGGER LEVEL for a stable display. You can use motor trigger to stabilize the display of complex, pulse-width modulated, motor drive waveforms.

Going Further

You can use the horizontal MAG function to get a closer look at the motor drive waveform.

To get an even closer look at a pulse in the waveform, place vertical cursors around the pulse of interest and use the delayed time base.

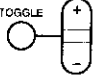
| | | | | |
|--|---|---|---|---|
|  METER  SCOPE |  |  |  |  |
| SCOPE | CURSOR | Cursor Function | V Bars | <i>Set cursors to pulse of interest</i> |
| | HORIZONTAL MENU | Set Delay With Cursor V Bars | — | — |



Reference

Introduction to Reference







This chapter contains detailed information about the operation of the THS710A, THS720A, THS730A, and THS720P TekScope instruments. The topics in this chapter are arranged alphabetically by button name.

| Reference Topic | Page |
|---------------------|------|
| Acquire | 3-3 |
| Autorange | 3-8 |
| Cursor | 3-11 |
| Display/Harmonics | 3-13 |
| Hard copy | 3-22 |
| Hold | 3-26 |
| Horizontal controls | 3-27 |
| Measure | 3-31 |
| Meter mode | 3-37 |
| Save/Recall | 3-43 |
| Scope mode | 3-46 |
| Trigger controls | 3-52 |
| Utility | 3-60 |
| Vertical controls | 3-66 |

ACQUIRE

Press the ACQUIRE button to set acquisition parameters independently for scope mode and meter mode.

Acquire Menu in Scope Mode

|  METER  SCOPE |  |  |  |  |
|--|---|---|---|--|
| SCOPE | ACQUIRE | Acquire Mode | Sample Peak Detect | — |
| | | | Envelope Average | <i>Set number of acquisitions</i> |
| | | Stop After | HOLD Button Only Single Acquisition Sequence | — |
| | | Force Trigger | — | — |

Key Points

Acquisition Modes. You can choose one of four acquisition modes: Sample, Peak Detect, Envelope, or Average. The next two pages describe these acquisition modes in detail.

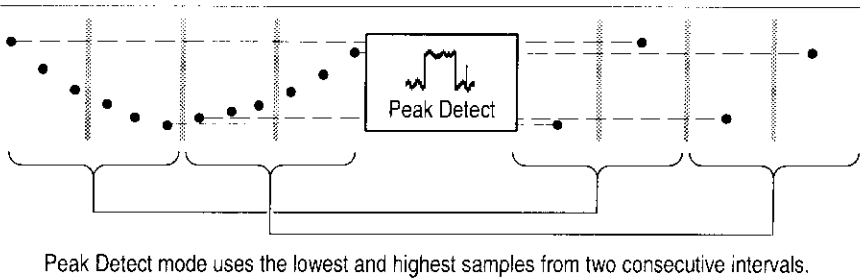
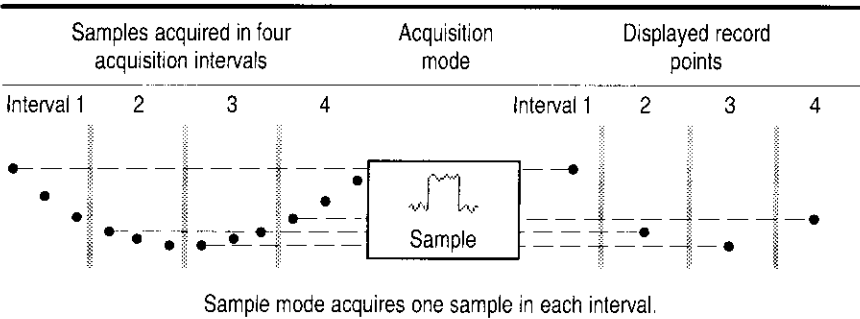

Sample. Use Sample acquisition mode for the fastest acquisition at any SEC/DIV setting. Sample mode is the default mode.

Peak Detect. Use Peak Detect acquisition mode to limit the possibility of aliasing. Also, use Peak Detect for glitch detection. You can see glitches as narrow as a 8 ns.

Peak Detect is only functional for sample rates up to 25 MS/s. For 50 MS/s and faster sample rates, the TekScope instrument switches to Sample acquisition mode automatically.

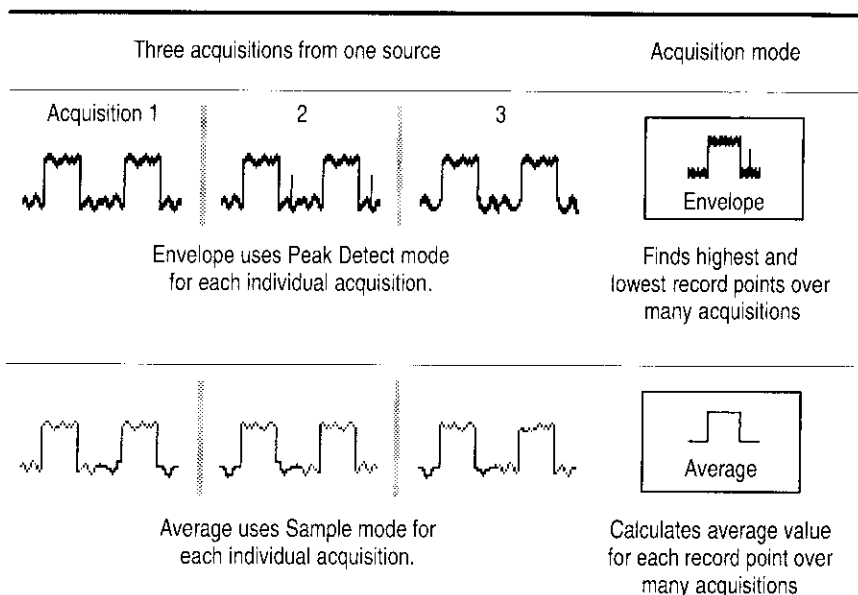

Envelope and Average. Use Envelope acquisition mode to capture variations of a signal over a longer period of time. Use Average acquisition mode to reduce random or uncorrelated noise in the signal you want to display.

The +/- rocker sets a specific number of acquisitions (N) to include in the enveloped or averaged waveform.

- The enveloped waveform clears and then starts over after N acquisitions.
- The averaged waveform is a running average over N acquisitions.
- If you select Stop After Single Acquisition Sequence, an envelope or average acquisition stops after N acquisitions.

If you probe a noisy square wave signal that contains intermittent, narrow glitches, the waveform displayed will vary depending on the acquisition mode you choose.

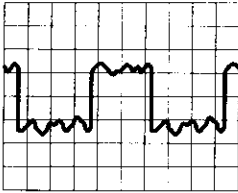

Sample

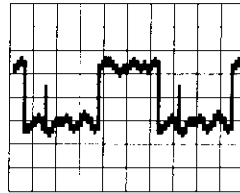

Peak Detect

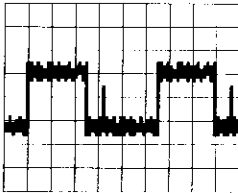

Envelope

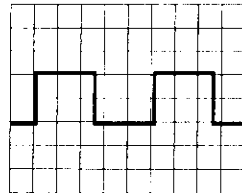



Average

Single Acquisition Sequence. The content of a single acquisition sequence depends on the acquisition mode.

| Acquisition Mode | Single Acquisition Sequence |
|-----------------------|---|
| Sample or Peak Detect | One acquisition of each displayed channel |
| Envelope or Average | N acquisitions of each displayed channel (N is user adjustable) |

Acquire Menu in Meter Mode

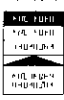
| | | | |
|---|---|---|---|
|  METER |  |  |  |
| METER | ACQUIRE | Acquire Mode | Sample Peak Detect Average |
| | | Rel Δ | On (Reset Δ) Off |

Key Points

Acquisition Modes. The data logger compresses a sequence of meter measurements into a point and then plots a series of those points to form a graph. The acquisition mode determines how the graph is calculated:

- For each point, Sample displays the first meter measurement from the sequence.
- Peak Detect displays a column representing the maximum and minimum meter measurements during the sequence.
- Average displays the average of all meter measurements during the sequence.

Rel Δ Measurements. Rel Δ acquires a new baseline value for subsequent DMM measurements. Use Rel Δ to store the current DMM value and then measure the relative change from that value. When you turn off Rel Δ , the baseline value resets to zero.

AUTORANGE

Autorange automatically adjusts setup values to track a signal. If the signal changes, the setup continues to change to track the signal. Autorange works independently in scope and meter modes. Refer to page 3–16 for additional autorange information for the THS720P.

The following controls are preset when you first select the autorange function.

| Scope Mode | Meter Mode |
|---|-------------|
| Acquire mode: Sample | <i>none</i> |
| Stop acquire after: HOLD button only | |
| Vertical coupling: DC (if GND was selected) | |
| Bandwidth: Full | |
| Invert: Off | |
| Horizontal position: Centered | |
| Horizontal magnification: Off | |
| Trigger type: Edge | |
| Trigger source: Lowest numbered channel displayed | |
| Trigger coupling: DC | |
| Trigger slope: Positive | |
| Trigger holdoff: Minimum | |
| Display style: Vectors | |
| Display format: YT | |

These conditions start an autorange cycle.

| Scope Mode | Meter Mode |
|--|---|
| Too many or too few waveform periods for a clear display of the lower-numbered channel | DMM reading exceeds ± 3600 counts or falls below ± 330 counts |
| Waveform amplitude too large or too small compared to full screen if only one channel is displayed | |
| Waveform amplitude too large or too small compared to half screen if two channels are displayed | |

Autorange adjusts these controls.





| Scope Mode | Meter Mode |
|-----------------------------|----------------|
| Vertical VOLTS/DIV adjusted | Range adjusted |
| Horizontal SEC/DIV adjusted | |
| Trigger level set to 50% | |

These control changes turn off autorange.

| Scope Mode | Meter Mode |
|--|--------------------------|
| Change to Stop After Single Acquisition Sequence | Change range (VOLTS/DIV) |
| Change VOLTS/DIV | |
| Change SEC/DIV | |
| Change trigger type | |
| Change trigger level | |
| Change trigger coupling | |
| Change trigger holdoff | |
| Change display format to XY | |
| Change display style | |

CURSOR

Press the **CURSOR** button to display the cursor menu. In scope mode, cursors operate on the 2500-point record of the selected waveform. In meter mode, they operate on the 250-point data logger plot.

|  METER  SCOPE |  |  |  |
|--|---|---|---|
| SCOPE | CURSOR | Cursor Function | Off H Bars V Bars Paired |
| | | Time Units | Seconds 1/seconds (Hz) Degrees |
| | | Set 0° and 360° with V Bars | — |
| METER | CURSOR | Cursor Function | Off H Bars V Bars Paired |

Key Points

Cursor Movement. Use the +/- rocker to move the active cursor. Press the **TOGGLE** button to change which cursor is active.

Fine Cursor Movement. If you first press **MAG**, you can set a cursor to any point in the 2500-point oscilloscope waveform.

Cursor Functions. H Bars measure voltage. V Bars measure time, frequency, or degrees. Paired measures both voltage and time, voltage and frequency, or voltage and degrees.

Measuring Phase. Move the V Bar cursors to the 0° and 360° points and then press the **Set 0° and 360° with V Bars** button. Next, move either cursor to the point you want to measure.

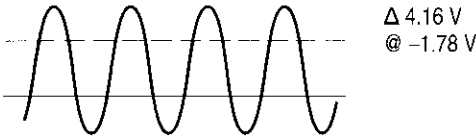

Horizontal Bar cursors

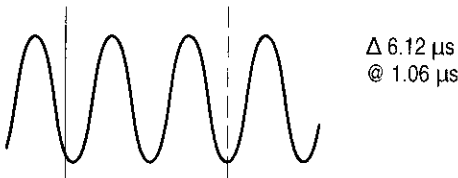

Vertical Bar cursors

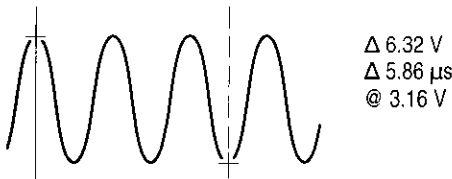







Paired cursors

@ Readout. For V Bar cursors, the readout after the @ symbol indicates the location of the active cursor relative to the trigger point. For degrees measurements, the readout is relative to the 0° and 360° points that you set. For H Bars or Paired cursors, it indicates the location relative to zero volts.

DISPLAY/HARMONICS

Press the DISPLAY button to choose how waveforms are presented and to change the appearance of the display. In the THS720P TekScope instrument, the DISPLAY button is also used to activate harmonics functions. Refer to page 3–16 for a description of harmonics.

Display Menu in Scope Mode

|  METER  SCOPE |  |  |  |  |
|--|---|---|---|---|
| SCOPE | DISPLAY | Harmonics (THS720P only) | Off | — |
| | | Display Style | Vectors Dots | — |
| | | | Vector Accumulate Dot Accumulate | <i>Set accumulate time</i> |
| | | Display Contrast | — | <i>Set contrast</i> |
| | | Graticule | Full Grid Cross Hair Frame | — |
| | | Format | YT XY | |

Key Points

Display Style. Choose one of the following waveform display styles:

- Vectors fills the space between adjacent sample points in the display. Widely spaced points are filled using $(\sin x)/x$ interpolation.
- Dots displays only the individual sample points.
- Vector Accumulate adds persistence to the vector display. Use the +/- rocker to set the accumulate time.
- Dot Accumulate adds persistence to the dot display. Use the +/- rocker to set the accumulate time.

NOTE. *Vector Accumulate and Dot Accumulate are display functions only. When you change most control settings, the accumulated data is cleared. Accumulated waveforms cannot be saved.*

XY Format. Choose XY display format when you want to display channel 1 in the horizontal axis and channel 2 in the vertical axis. The controls operate as follows:

- The channel 1 VOLTS/DIV and vertical POSITION controls now set the horizontal scale and position.
- The channel 2 VOLTS/DIV and vertical POSITION controls continue to set vertical scale and position.
- The SEC/DIV and horizontal POSITION controls affect the time base and the portion of the waveform that is displayed.

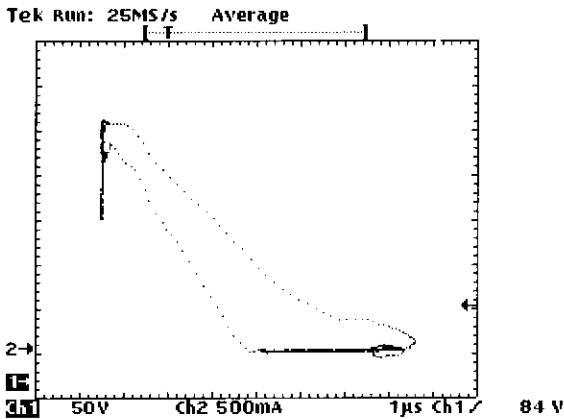







NOTE. The above XY-display example shows the I-V characteristic of a switching power MOSFET. The current waveform, displayed in the vertical axis, is measured using a Tektronix A6302 current probe and AM503B current-probe amplifier.

The following functions do not work in XY display format:

- Ref or Math waveforms
- Cursors
- Horizontal MAG
- Autorange (resets display format to YT)

Display Menu in Harmonics Mode (THS720P)

| | | | | |
|--|---|---|---|---|
|  METER  SCOPE |  |  |  |  |
| SCOPE | DISPLAY | Harmonics | On | — |
| | | Show | All from Odd from Even from | <i>Select group of harmonics</i> |
| | | Display Contrast | — | <i>Set contrast</i> |
| | | THD Method | THD-F THD-R | — |
| | | Probes | Ch 1 Probe Ch 2 Probe | <i>Set conversion factor or probe attenuation</i> |

Key Points

Instrument Settings. When you turn on Harmonics, the TekScope instrument is automatically configured as shown below. If you change the settings, measurement accuracy is not guaranteed.

- The DMM, REF A, REF B, and cursors are turned off.
- The channel 1 probe type is set to Voltage. The channel 2 probe type is set to Current. Math is set to $Ch\ 1 \times Ch\ 2$.
- The channels are set to DC coupling, Invert off, and 20 MHz bandwidth limit.
- The trigger is set to Edge, Ch 1 source, DC coupling, positive slope, auto mode, and minimum holdoff.
- The vertical, horizontal, and trigger settings are controlled by the autorange function.
- The acquisition mode is set to Average 16.

THD Calculation. Choose THD Method to specify whether Total Harmonic Distortion is calculated relative to the fundamental or to the RMS of the input signal.

Harmonics Display (THS720P)

Press CH 1 to display the voltage harmonics or press CH 2 to display the current harmonics. The harmonics display, shown below, is divided into five sections. The next three pages identify the content of each section in detail.

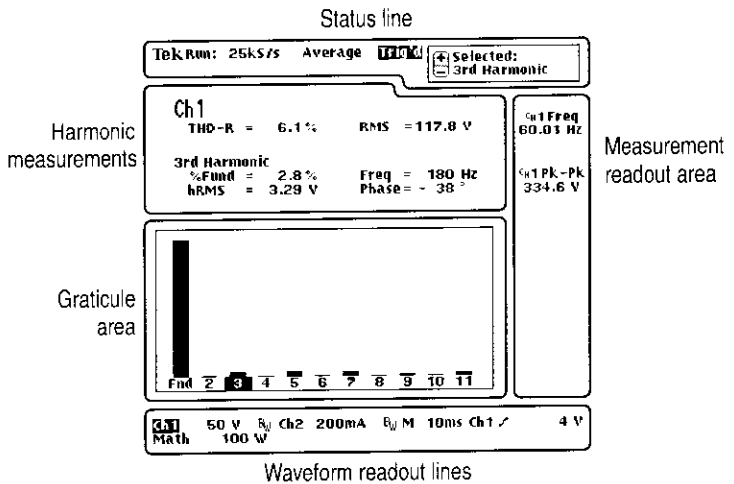

Press MATH to display the power measurements. Refer to *Power Measurements* on page 3-20 for more information.

Status Line. The status line across the top of the display contains acquisition and trigger information similar to scope mode display. Refer to page 3-47 for more information. The harmonics indicator shows the currently selected harmonic. Press the +/- rocker to display power measurements for the next/previous harmonic.

Harmonic Measurements. The readout lines above the graticule contain harmonic measurements for the waveform and the selected harmonic.

Ch1

THD-R = 6.1 % RMS = 117.8 V

3rd Harmonic

%Fund = 2.8 % Freq = 180 Hz
hRMS = 3.29 V Phase = - 38 °

| Harmonic Measurements | Explanation |
|-----------------------|--|
| THD-F or THD-R | Total harmonic distortion of the waveform as a percentage of the fundamental (THD-F) or of the RMS of the input signal (THD-R) |
| RMS | RMS value of the input signal over one cycle |
| %Fund | Amplitude of the selected harmonic as a percent of the fundamental |
| hRMS | RMS value of the selected harmonic in volts or amperes |
| Freq | Frequency of the selected harmonic |
| Phase | Phase of the selected harmonic relative to the phase of the fundamental |

Message Line. A message, such as “Low Amplitude,” is displayed in the message line when the input signals do not meet the conditions necessary to take accurate measurements. Correct the condition before proceeding.

Measurement Readouts. The area to the right of the graticule contains measurement readouts similar to scope mode display. Refer to page 3-51 for more information.

Waveform Readout Lines. The readout lines below the graticule contain specific information about the waveform similar to scope mode display. Refer to page 3-49 for more information.

Graticule Area. The graticule area contains a bargraph of the harmonics. To display the harmonic content of the voltage waveform, press CH 1. To display current harmonics, press CH 2.

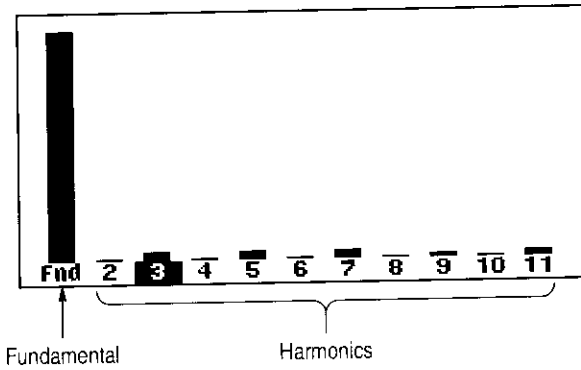

Power Measurements (THS720P)

When you press the MATH button, the TekScope instrument displays instantaneous power measurements based on the voltage and current waveforms. In the box, the instrument calculates power statistics that accumulate from the beginning of the acquisition.

Math





W = 26.23 W **PF = 0.56**
VA = 47.07 VA **DPF = 0.89**
VAR = 39.09 VAR **θ = 28°**

| | Average | Minimum | Maximum |
|------------|------------------|------------------|------------------|
| W | 25.67 W | 26.16 mW | 26.26 W |
| VA | 46.2 VA | 4.719 VA | 47.33 VA |
| VAR | 38.39 VAR | 4.719 VAR | 39.37 VAR |
| V | 117.9 V | 117.7 V | 118.3 V |
| A | 392 mA | 39.94 mA | 400.5 mA |

| Power Measurements | Explanation |
|--------------------|--|
| W | True power |
| VA | Apparent power |
| VAR | Reactive power |
| PF | True power factor of the voltage and current waveforms |
| DPF | Displacement power factor of the voltage and current waveforms |
| θ | Phase difference between the voltage and current waveforms |

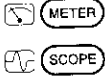
Refer to page A-9 for more detail about the power measurements and calculation methods.

Display Menu in Meter Mode

| | | | | |
|---|---|---|---|---|
|  |  |  |  |  |
| <p>METER</p> | <p>DISPLAY</p> | <p>Line Style</p> | <p>Thin Thick</p> | <p>—</p> |
| | | <p>Display Contrast</p> | <p>—</p> | <p><i>Set contrast</i></p> |
| | | <p>Graticule</p> | <p>Full Grid Cross Hair Frame</p> | <p>—</p> |

Key Points

Data Logger Line Style. For better visibility, choose Thick for a three-pixel-high data logger plot. The default (Thin) is one pixel high.

HARD COPY

You can print a hard copy of the display if a printer is connected and properly configured. Press the HARD COPY button to start printing. If you do not want menus to show, press CLEAR MENU before you press HARD COPY. You cannot change instrument settings while the hard copy is printing.

Connecting a Printer



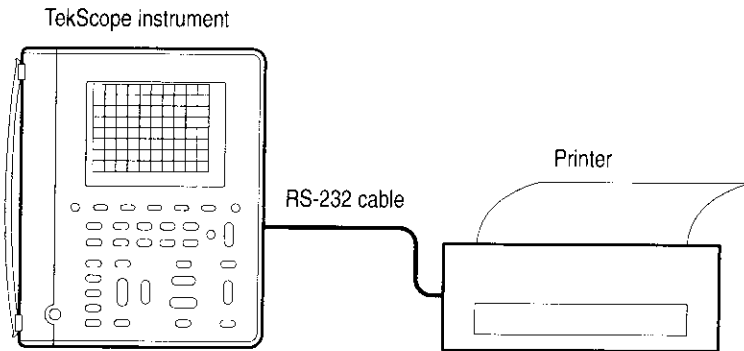

Use the RS-232 cable to connect the printer to the RS-232 port on the side of the TekScope instrument. The RS-232 accessory kit includes an adapter for 9-pin RS-232 connectors.

- Refer to *RS-232 System* on page 3–62 for information about setting the TekScope instrument for RS-232 communication with your printer.
- Refer to the user manual for your printer for information about setting its baud rate and any other required parameters.
- Refer to *Making the Connection* on page 3–24 for information about RS-232 cables and adapters.



Setting Up to Print

Perform the following steps to choose the printer and page layout:

| | | | |
|---|---|---|---|
|  |  |  |  |
| SCOPE or METER | UTILITY | System | Hard Copy |
| | | Layout | Landscape Portrait |
| | | Format | <i>three pages of formats</i> |
| | | Select Page | — |
| | | OK Select Format | — |

The following printer and file formats are supported:

- BMP (Microsoft Windows file format)
- Deskjet (high resolution printer format)
- DPU 411/II, HC 411 (thermal printer format)
- DPU 412 (thermal printer format)
- EPS Image (encapsulated postscript image file format)
- Epson (9-pin and 24-pin dot matrix printer format)
- Interleaf .img (image object file format)
- Laserjet (laser printer format)
- PCX (PC Paintbrush monochrome image file format)
- Thinkjet (inkjet printer format)
- TIFF (tag image file format)

Making the Connection

Use the table below to help you connect the TekScope instrument to your PC or serial printer. You must use an RS-232 cable for each device type. Adapters not supplied with the TekScope instrument are commonly available at computer supply dealers.

| RJ-45 to 9-pin female null modem adapter (standard) | RJ-45 to 25-pin male adapter ¹ | 9-pin male to 25-pin male adapter ² | 25-pin female to female gender adapter ³ | |
|--|---|--|---|---|
| HC 411 or DPU 411-II printer | | ● | | |
| Thinkjet printer with 24542G cable and 9-pin male gender adapter | ● | | | |
| Most other serial printers | ● | | ● | |
| Sun workstations | ● | | ● | |
| PC/AT or laptop with 9-pin male connector | ● | | | |
| PC with 25-pin male connector | ● | | ● | ● |

- ¹ Tektronix part number 103-0334-XX (supplied with HC 411)
- ² Radio Shack part number 26-1388 or equivalent
- ³ Radio Shack part number 26-1495 or equivalent

Troubleshooting RS-232 Problems

If the TekScope instrument and the personal computer or printer have trouble communicating, use the following steps to correct the problem:

- Verify that you are using the correct RS-232 cable and adapters. Determine whether your configuration requires a null-modem connection (where transmit/receive and control lines are switched) or a straight-through RS-232 connection.
- Verify that the RS-232 cable and adapters are firmly connected to both the TekScope instrument and the correct port on your personal computer or printer. Verify that your printer or the program on the personal computer is using the correct port. Try your program or printer again.
- Verify that the TekScope instrument settings match the settings used by your printer or the program on your personal computer. Start by choosing Set RS-232 Parameters to Defaults (in the RS-232 System of the Utility menu). Then, change only those menu items that you know need to be changed, such as the baud rate. Try your printer or computer program again.

HOLD

Press the HOLD (RUN/STOP) button to stop and start data acquisition. Because scope mode and meter mode have independent acquisition states, the HOLD button operates independently for these two modes.



Hold Function in Scope Mode

In scope mode, the function of the HOLD button depends on the Stop After selection in the acquire menu.

| Acquire Menu Setting | Functions of HOLD Button |
|--|--|
| Stop After HOLD Button Only | First press stops waveform acquisition. Second press restarts waveform acquisition. |
| Stop After Single Acquisition Sequence | Any press starts a new acquisition sequence. The acquisition sequence stops automatically. |



Hold Function in Meter Mode

In meter mode, pressing the HOLD button once freezes the meter reading, the measurement statistics (MIN, MAX, and AVG), and the data logger display.

A second press of the HOLD button resets and restarts the data logger display and measurement statistics, and then restarts the meter readings.





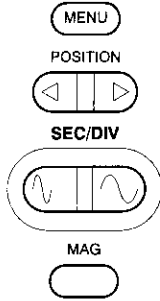

HORIZONTAL Controls

You can use the horizontal controls to change the time base, horizontal position, and horizontal magnification of waveforms.

■ HORIZONTAL ■



Horizontal Operations in Scope Mode

|  METER  SCOPE |  |  |  |  |
|--|---|---|---|---|
| SCOPE | HORIZONTAL MENU | Time Base | Main | — |
| | | | Delayed Runs After Main | <i>Set delay time</i> |
| | | Trigger Position | Set to 10% Set to 50% Set to 90% | — |
| | | | % Pretrigger | <i>Set %</i> |
| | | Display 'T' at Trig Pt | On Off | — |
| Set Delay With Cursor V Bars | — | | | |

Key Points

SEC/DIV Rocker. If waveform acquisition is stopped (using the HOLD button), changes you make to the time base have no effect until you restart acquisition.

Roll Mode Display. To obtain a rolling display similar to a strip-chart recorder, select Auto trigger mode and set SEC/DIV to 500 ms/div or slower.

POSITION Rocker. You can position each of the two reference waveforms (Ref A and Ref B) independently of the three live waveforms (Ch 1, Ch 2, and Math). Or you can set the horizontal position of all waveforms track each other. Refer to *Ref A or Ref B Vertical Menu* on page 3–69 for information about this capability.

MAG Button. To switch between the normal and magnified displays, press the MAG button.

- Normal display compresses the 2500-point waveform by a factor of ten to form 250 horizontal points in the display.
- Magnified display expands the horizontal scale by a factor of ten and displays one waveform point per pixel.
- Use the POSITION rocker to choose the section of the waveform to magnify. The horizontal-position indicator shows you the location of the magnified segment in the full waveform record.

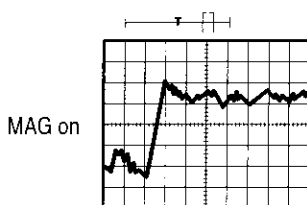
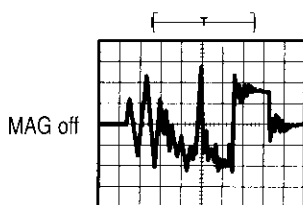

Readout. The waveform readout shows the horizontal scale factor below the graticule. Page 3–46 shows the location of this readout.

Time Base. Choose the Main or Delayed time base. The delayed time base runs at the preset delay time after the trigger event for the main time base. Use the +/- rocker to set the delay time directly.

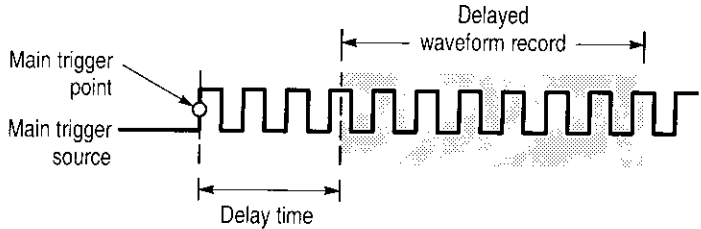





Set Delay with Cursor V Bars. Place the V Bar cursors around an area of interest after the trigger point. Press Set Delay with Cursor V Bars to set the delayed time base and delay time to view the area between the cursors in detail.

Trigger Position. Choose the amount of pretrigger:

- Set to 10% places the trigger point near the beginning of the waveform record
- Set to 50% places the trigger point at the center of the waveform record
- Set to 90% places the trigger point near the end of the waveform record
- You can also set any amount of pretrigger (0% to 100%) with the +/- rocker

Display 'T' at Trig Pt. The trigger point on the waveform is marked with the T symbol. The T symbol can be turned on or off.

Horizontal Operations in Meter Mode

| | | | |
|---|---|---|---|
|  |  |  |  |
| <p>METER</p> | <p>HORIZONTAL MENU</p> | <p>—</p> | <p>—</p> |

Key Points





SEC/DIV Rocker. To adjust the scroll speed of the data logger plot, use the SEC/DIV rocker. If you change the scroll speed, data in the logger display is erased.

Other Controls. The POSITION rocker and MAG button have no effect in meter mode.

MEAS

You can use the MEAS button to access the automatic measurement capability of the TekScope instrument. In scope mode, the instrument measures the 2500-point, selected waveform. In meter mode, the measurements take the form of statistics, which are calculated from successive meter readings.

Measurements in Scope Mode

|  METER |  |  |  |  |
|---|---|---|---|---|
| SCOPE | MEAS | Select Measmnt | <i>six pages of measurements</i> | — |
| | | Select Page | — | |
| | | Remove Measmnt | Measmnt | <i>Choose measurement</i> |
| | | | All Measmnts | — |
| | | High-Low Setup | Histogram Min-Max | |
| | | OK Select Measmnt | — | |
| | | OK Remove Measmnt | | |

Key Points

Choosing Measurements. You can perform up to four automatic measurements on the selected waveform and display them along the right side of the graticule. The table beginning on page 3–33 describes the scope-mode measurements in detail.



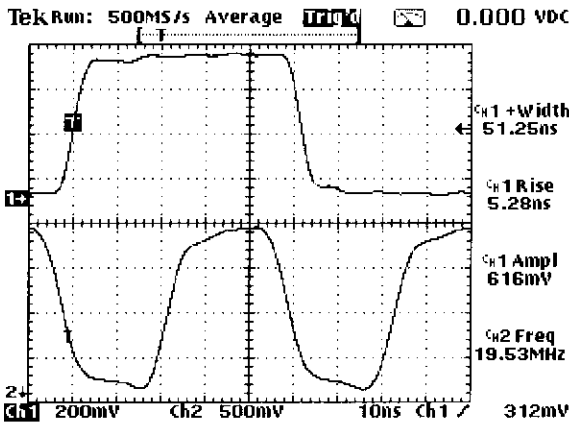







Power Measurements (THS720P). Refer to page 3–20 for information about power measurements.













High-Low Setup. The TekScope instrument determines the 10%, 50%, or 90% levels of the selected waveform and then uses them to calculate the measurements. You can choose the method used to determine these levels:

- Histogram sets the values statistically; it finds the most common value either above or below the midpoint (depending on whether it is defining the high or low reference level). Since this statistical approach ignores short-term aberrations (overshoot, ringing, noise), histogram is the best method for measuring digital waveforms and pulses.
- Min-max uses the highest and lowest values of the waveform record. This method is best for measuring waveforms that have no large, flat portions at a common value, such as sine waves and triangle waves.







Scope-Mode Measurement Definitions

| Name | Definition |
|---|---|
|  Ampl | Measured over the entire waveform. <i>Amplitude = High (100%) – Low (0%)</i> |
|  BrstW | The duration of a burst. Measured over the entire waveform. |
|  cMean | The arithmetic mean over the first cycle in the waveform. |
|  cRMS | The true Root Mean Square voltage over the first cycle in the waveform. |
|  Fall | Time that the falling edge of the first pulse in the waveform takes to fall from 90% to 10% of its amplitude. |
|  Freq | Reciprocal of the period of the first cycle in the waveform. Measured in Hertz (Hz). |
|  High | The value used as 100%. Calculated using either the min/max or the histogram method. Measured over the entire waveform. |
|  Low | The value used as 0%. Calculated using either the min/max or the histogram method. Measured over the entire waveform. |
|  Max | The maximum amplitude. The most positive peak voltage measured over the entire waveform. |
|  Mean | The arithmetic mean over the entire waveform. |
|  Min | The minimum amplitude. The most negative peak voltage measured over the entire waveform. |

Scope-Mode Measurement Definitions (Cont.)

| Name | Definition |
|---|--|
|  -Duty | Measurement of the first cycle in the waveform. $\text{Negative Duty Cycle} = \frac{\text{Negative Width}}{\text{Period}} \times 100\%$ |
|  -Over | Measured over the entire waveform. $\text{Negative Overshoot} = \frac{\text{Low-Min}}{\text{Amplitude}} \times 100\%$ |
|  -Width | Measurement of the first negative pulse in the waveform. The time between the 50% amplitude points. |
|  Pk-Pk | Measured over the entire waveform. $\text{Amplitude} = \text{Max} - \text{Min}$ |
|  Period | Time it takes for the first complete signal cycle to complete in the waveform. Measured in seconds. |
|  +Duty | Measurement of the first cycle in the waveform. $\text{Positive Duty Cycle} = \frac{\text{Positive Width}}{\text{Period}} \times 100\%$ |
|  +Over | Measured over the entire waveform. $\text{Positive Overshoot} = \frac{\text{Max-High}}{\text{Amplitude}} \times 100\%$ |
|  +Width | Measurement of the first positive pulse in the waveform. The time between the 50% amplitude points. |
|  Rise | Time that the leading edge of the first pulse in the waveform takes to rise from 10% to 90% of its amplitude. |
|  RMS | The true Root Mean Square voltage over the entire waveform. |

Measurements in Meter Mode

|  METER  SCOPE |  |  |  |  |
|--|---|---|---|---|
| METER | MEAS | Select Statistic for DMM | Max Avg Min Rel Δ Max - Min | — |
| | | Select Page | — | — |
| | | Remove Statistic | Statistic | <i>Choose statistic</i> |
| | | | All Statistics | — |
| | | Beep New Max-Min | On Off | — |
| OK Select Statistic OK Remove Statistic | — | — | | |

Key Points

Data Included in Statistics. The statistics are calculated over all meter readings since the last reset. The statistics can represent data that is no longer displayed in the data logger plot.

Readout. The statistic readouts appear in the upper-right corner of the display. See page 3–37 for the location.

Choosing Statistics. Choose up to three from the following statistics.

| Statistic | Definition |
|-----------------------------|---|
| Max | The maximum value of all meter readings since the last reset. |
| Avg | The arithmetic average of all meter readings since the last reset. |
| Min | The minimum value of all meter readings since the last reset. |
| ΔO | The baseline value used in the Rel Δ calculation. This value is updated only when the Rel Δ function is turned on or off. |
| Max-Min | The difference between the maximum and minimum meter readings since the last reset. |

Reset Conditions. The calculated statistics are reset to zero if you make any of the following control changes:

- Turn off the HOLD function
- Change the measurement function (from VAC to VDC, for example)
- Change the probe scale factor
- Change the Rel Δ value
- Change the data logger scroll speed

Beep New Max/Min. You can turn on a beep that sounds any time the TekScope instrument updates the Max or Min statistic.

METER Mode



Press the METER button to enter meter mode. The meter reading and statistics update about three times per second.

| | | | |
|----------------|-------|---------------------|---|
| METER SCOPE | | | |
| METER | METER | VAC | — |
| | | VDC | — |
| | | Ω | — |
| | |))) (continuity) | — |
| | | (diode) | — |

The meter-mode display, shown below, is divided into three sections. The next two pages identify the content of each section in detail.

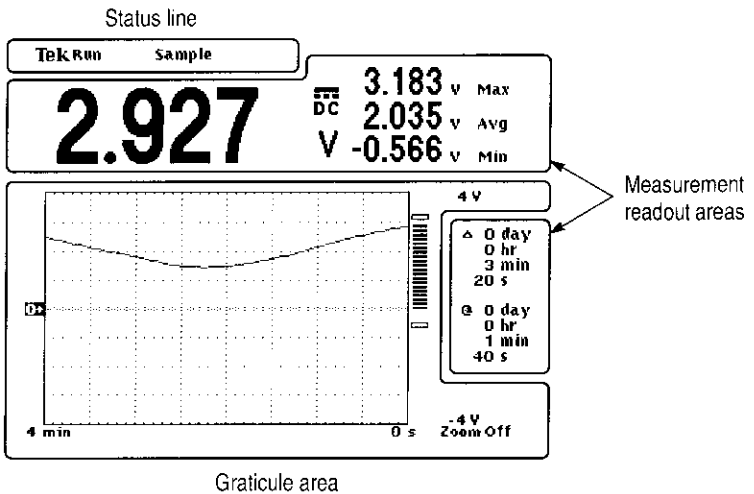

Status Line

The status line across the top of the display contains acquisition information. The overrange indicator warns when an overvoltage is applied to the input.

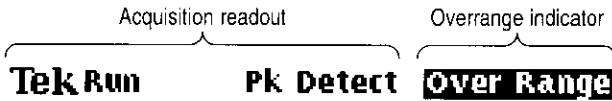

The table below shows examples of the acquisition readout.

| Acquisition Readout | Explanation |
|---------------------|--|
| AUTO RANGE | Acquisition running with autorange function on (AUTO RANGE) or off (Run), or acquisition is stopped (Hold) |
| Run | |
| Hold | |
| Data: 7 | Saved data is recalled for display (from location 7) while acquisition runs in the background |
| Sample | Acquisition mode for data logger |

Graticule Area

The graticule area contains the data logger plot, the bar graph, their scale markers, and the zoom factor readout.

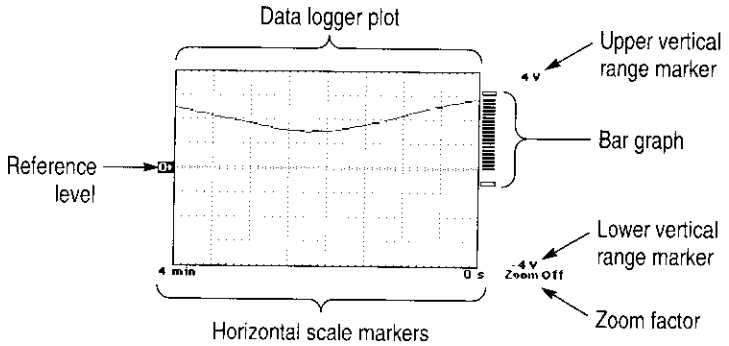

Measurement Readout Area

The area above and to the right of the graticule contains the current meter reading, statistic readouts, and cursor readouts.

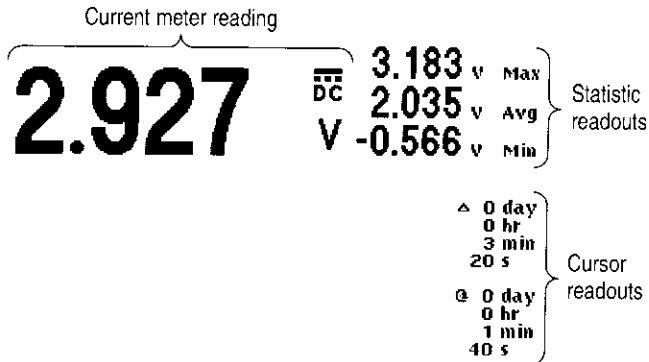

Data Logger Display

The data logger records meter measurements over a period of time, creating a plot similar to a strip-chart recorder. You can set the time span of the plot from four minutes to eight days.

The data logger plot scrolls to the left. The most recent data is always at the right end of the graticule. The oldest data disappears off the left side of the graticule and is erased.

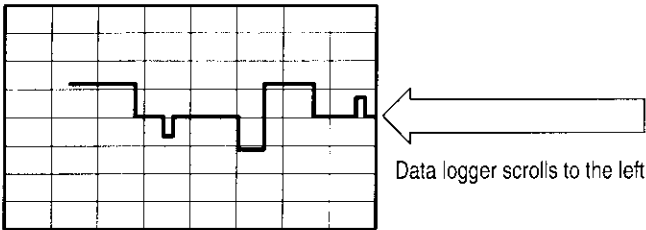

Reset. The TekScope instrument erases the waveform in the data logger plot if you make any of the following control changes:

- Turn off the HOLD function
- Change the measurement function (from VAC to VDC, for example)
- Change the probe scale factor
- Change the Rel Δ value
- Change the data logger scroll speed

Zero Level. If you select the VDC meter function, the zero level is located at the horizontal centerline of the graticule; for all other meter functions, the zero level is the bottom of the graticule. Use the vertical POSITION rocker to move the zero level.

Reference Level. If the Rel Δ function is turned on, the Rel Δ baseline value is marked along the left side of the graticule.

VOLTS/DIV Rocker. Use the VOLTS/DIV rocker to set the meter range and control the vertical scale of the data logger plot. If you change the vertical scale while the data logger is running, you will cause a vertical discontinuity; old data is not rescaled to match the current setting. However, if you change the vertical scale while the HOLD function is active, the entire waveform is scaled to match the current setting.

SEC/DIV Rocker. Use the SEC/DIV rocker to control the scroll speed of the data logger plot. When you change the scroll speed, existing data in the data logger plot is erased.

Zoom. You can vertically enlarge the data logger plot around the center of the screen for the VDC function, and around the bottom of the screen for other functions. The zoom feature allows you to see the full vertical resolution of the meter.

Use the vertical POSITION rocker to move the plot before choosing Zoom. Then, choose Zoom in the Vertical Menu to set the zoom factor (refer to page 3-70). If you change the range or function, the plot position and size are reset to their default values.

Bar Graph

The rapid update rate of the bar graph simulates an analog meter movement. The bar graph is displayed just to the right of the data logger display and uses the vertical axis of the data logger display as its scale. The bar graph extends from zero (or the Rel Δ baseline value) to the current meter measurement. It tracks the meter measurement rate and updates about ten times per second.

In addition, the bar graph contains two hollow segments that represent the current values of the Min and Max statistics.

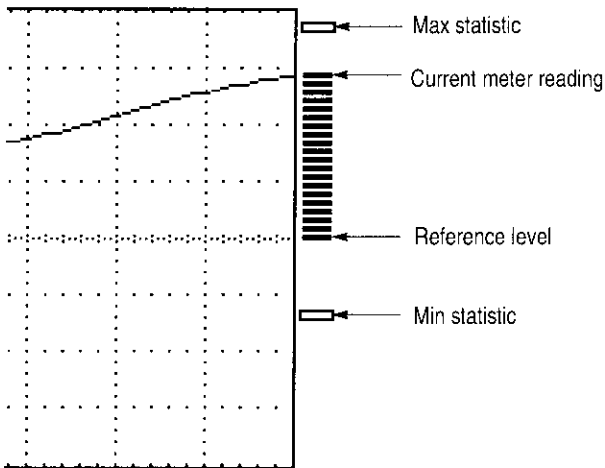

For More Information





Many of the other sections in this chapter contain additional information about meter-mode menus and operation. Please refer to those sections, which are arranged alphabetically by button name.

SAVE/RECALL

Press the SAVE/RECALL button to save or recall any of the following:

- Setups
- Oscilloscope waveforms
- DMM Data

Save/Recall Menu in Scope Mode

|  |  |  |  |  |
|---|---|---|---|---|
| SCOPE | SAVE/ RECALL | Save Current Setup | To Setup | <i>Choose setup location</i> |
| | | Recall Saved Setup | Recall Factory Setup | — |
| | | | Recall Setup | <i>Choose setup location</i> |
| | | Save selected wfm | To Waveform | <i>Choose waveform location</i> |
| | | Recall Saved Waveform | Load REFA From Wfrm Load REFB From Wfrm | |
| | | OK Save Setup OK Recall Setup OK Recall Factory OK Save Waveform OK Recall Waveform | — | — |

Key Points

Saving and Recalling Setups. Whether you save a setup in scope mode or meter mode, the TekScope instrument stores its complete setup in nonvolatile memory. When you recall the setup, you will be in the mode from which the setup was saved.

Recalling the Factory Setup. You can recall the Factory Setup to initialize the TekScope instrument to a known setup. *Appendix B* describes the Factory Setup in detail.

Saving a Waveform. Push the CH 1, CH 2, or MATH button to choose the waveform to save. Waveform position and scale factors are saved with each waveform.







Recalling a Waveform. Recall a saved waveform into either Ref A or Ref B for display. When you recall a saved waveform, the recalled waveform overwrites the previous Ref A or Ref B waveform.

Saving and Displaying a Waveform in One Step. Using a vertical menu, you can save a waveform and keep it for display at the same time. Refer to *Ref A or Ref B Vertical Menu* on page 3–69 for information about this capability.

Saving Harmonics Data (THS720P). If you save the channel 1 or channel 2 waveform while the harmonics display is on, the harmonic measurements and bargraphs are also saved. When you recall the waveform, turn the harmonics display on to see the harmonics measurements and bargraphs.

Saving Power Measurement Data (THS720P). If you save the MATH waveform while the harmonics display is on, the power measurements are also saved. When you recall the waveform, turn the harmonics display on to see the power measurements.

Save/Recall Menu in Meter Mode

|  METER  SCOPE |  |  |  |  |
|--|---|---|---|---|
| METER | SAVE/ RECALL | Save Current Setup | To Setup | <i>Choose setup location</i> |
| | | Recall Saved Setup | Recall Factory Setup | — |
| | | | Recall Setup | <i>Choose setup location</i> |
| | | Save DMM Data | To Data | <i>Choose DMM data location</i> |
| | | Recall DMM Data | Recall Data Clear Data From Screen | |
| | | OK Save Setup | — | — |
| OK Recall Setup | | | | |
| OK Recall Factory | | | | |
| OK Save Data | | | | |
| OK Recall Data | | | | |
| OK Clear Data | | | | |

Key Points

Saving and Recalling Setups. Whether you save a setup in scope mode or meter mode, the TekScope instrument stores its complete setup in nonvolatile memory.

Saving DMM Data. Saving DMM data saves the meter mode, meter range, current DMM reading, statistics, and data logger plot.

SCOPE Mode



Press the SCOPE button to enter scope mode. If already in scope mode, pressing this button has no effect.

The scope-mode display, shown below, is divided into four sections. The next five pages identify the content of each section in detail.

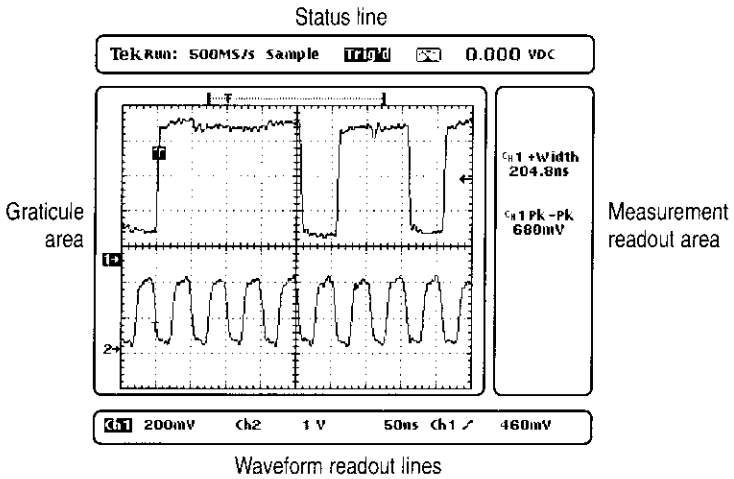

Status Line

The status line across the top of the display contains acquisition and trigger information.

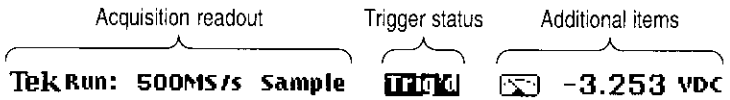



The table below shows acquisition readout examples that are displayed when acquisition is running. When you press HOLD to stop acquisition, the readout shows the number of waveforms acquired since acquisition was last stopped.

| Acquisition Readout | Explanation |
|---------------------|---|
| AUTO RANGE | Acquisition running with autorange function on (AUTO RANGE) or off (Run:) |
| Run: | |
| 25MS/s | Current sample rate |
| Pk Detect | Acquisition mode |

The table below shows the meaning of the trigger status indicators.

| Trigger Status | Explanation |
|----------------|--|
| AUTO | Free-running in Auto trigger mode |
| TRIG | Waiting for trigger in Normal trigger mode |
| PpTRIG | Acquiring new pre-trigger data |

The table below shows examples of additional items that are sometimes displayed in the status line.

| Additional Items | Explanation |
|--|---|
|  -3.253 vdc | DMM icon and current DMM reading |
|  Delay:  1.014 μs | Parameter and its current value (only when the +/- rocker is assigned to a parameter) |
| Ext Trig | Indicates that the DMM input is being used for external trigger. |

Graticule Area

The graticule area contains waveforms and position indicators.

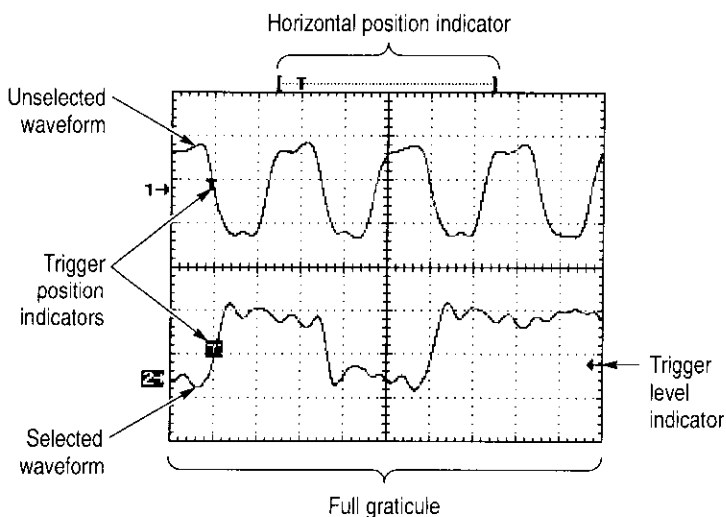

Waveform Readout Lines

The readout lines below the graticule contain specific information about displayed waveforms. The top line displays vertical readout for channel 1 and channel 2. The bottom line displays readout for Ref A, Ref B, or Math, whichever waveform was selected last.

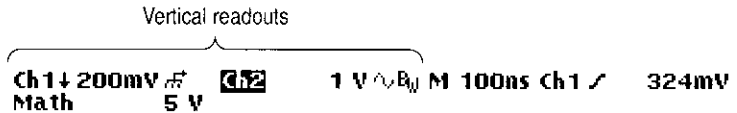

The table below shows examples of the vertical readout symbols.

| Vertical Readout Symbols | Explanation |
|--------------------------|--|
| Ch2 | Selected waveform |
| Ch1 | Unselected waveform |
| \downarrow | Inverted channel |
| \Downarrow | GND coupling |
| \sim | AC coupling |
| B _W | Bandwidth limit on |
| B-8 | Reference waveform Ref B recalled from waveform storage location eight |

The waveform readout lines also show time base and trigger information.

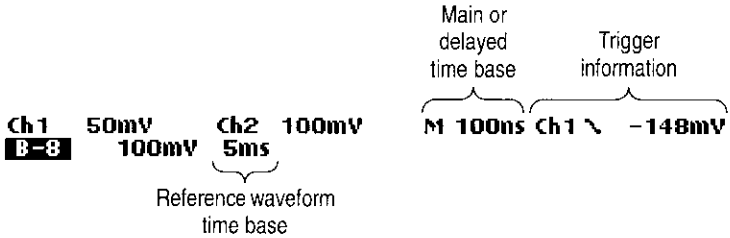

The table below shows examples of time base information.

| Time Base Information | Explanation |
|-----------------------|-------------------|
| M | Main time base |
| D | Delayed time base |

The table below shows examples of the trigger information.

| Trigger Information | Explanation |
|-----------------------------|-------------------------|
| Ch1 | Trigger source |
| ~ | Edge trigger slope |
| -148mV | Trigger level |
| ∩ | Pulse trigger polarity |
| > | Pulse trigger condition |
| 990ns | Pulse trigger width |
| Even Field Line: 146 | Video trigger condition |

Measurement Readout Area

The area to the right of the graticule contains cursor and measurement readouts. If a measurement qualifier appears with a measurement result, the signal may be insufficient to take an accurate measurement.

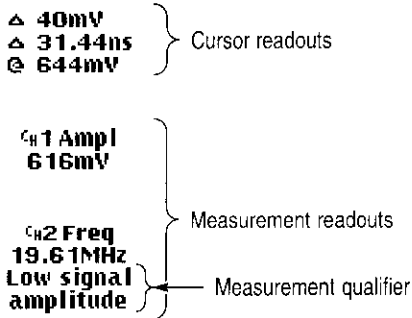

For More Information

Many of the other sections in this chapter contain additional information about scope-mode menus and operation. Please refer to those sections, which are arranged alphabetically by button name.

TRIGGER Controls



Triggering is an oscilloscope-only function; the trigger controls, shown below, have no effect in meter mode.

■ TRIGGER ■



TRIGGER
LEVEL













SET LEVEL
TO 50%



The trigger types are the following:







- Edge triggers on the rising or falling edge of the input signal (see page 3–54).
- Pulse triggers on specific events that you can qualify by time (see page 3–56).
- Video triggers on a specific line in the odd or even field, or on all the lines of an NTSC, PAL, or SECAM standard video signal (see page 3–58).
- Motor triggers (THS720P) on bipolar, motordrive waveforms (see page 3–59).

Use the leftmost button in the trigger menu to choose the trigger type. The remaining items in the trigger menu depend on the trigger type you choose.

| Edge or Motor | | Pulse | | Video | |
|------------------------------|---|-----------------------------|--|-------------------|---|
| Source | Choose Ch 1, Ch 2, or External (Edge only) | Source | Choose Ch 1 or Ch 2 | Source | Choose Ch 1 or Ch 2 |
| Coupling (Ch1 or Ch2) | DC  | Polarity & width | Positive ¹  | Trigger on | Odd Field ³ (Interlaced) |
| | HF Reject  | | Negative ¹  | | Even Field ³ (Interlaced) |
| | LF Reject  | | ¹ Set pulse width with +/- rocker | | Any Field ³ (Non-interlaced) |
| | Noise Rej (DC Low Sensitivity) | | | | Lines ³ Choose line with +/- rocker |
| Slope | Positive  | Trigger when | Less Than Width  | Scan rate | 15 kHz to 20 kHz |
| | Negative  | | Greater Than Width  | | 20 kHz to 25 kHz |
| | | | Equal To Width ²  | | 25 kHz to 35 kHz |
| | | | Not Equal To Width ²  | | 35 kHz to 50 kHz |
| | | | ² Set tolerance | | 50 kHz to 65 kHz |

Edge Trigger

Use Edge triggering to trigger on the rising or falling edge of the input signal at the trigger threshold.

| | | | | |
|--|---|---|---|---|
|  METER  SCOPE |  |  |  |  |
| SCOPE | TRIGGER MENU | Trigger Type | Edge | — |
| | | Trigger Source | Ch1 Ch2 Ext. [DMM] | |
| | | Trigger Coupling (Ch 1 or Ch 2 source only) | DC HF Reject LF Reject Noise Reject | |
| | | Trigger Slope | / (<i>rising edge</i>) \ (<i>falling edge</i>) | |
| | | Mode & Holdoff | Auto Normal | <i>Set holdoff</i> |

Key Points

Normal and Auto Mode. Use Normal trigger mode when you want the oscilloscope to trigger only on a valid trigger. Use Auto trigger mode when you want the acquisition to free-run in the absence of a valid trigger event. Also, choose Auto when you want an untriggered, rolling waveform at 500 ms/div or slower time base settings.

External Trigger. Use external trigger to trigger on a signal connected to the DMM inputs. External trigger coupling is always DC. You can choose either a 0.2 V or a 2 V trigger level.

Holdoff. You can use holdoff to help stabilize the display of complex waveforms. After you press the Mode & Holdoff menu button, use the +/- rocker to set the holdoff time from 500 ns to 10 s.

Holdoff begins when the TekScope instrument recognizes a trigger event and disables the trigger system until acquisition is complete. The trigger system remains disabled during the holdoff time that follows each acquisition.

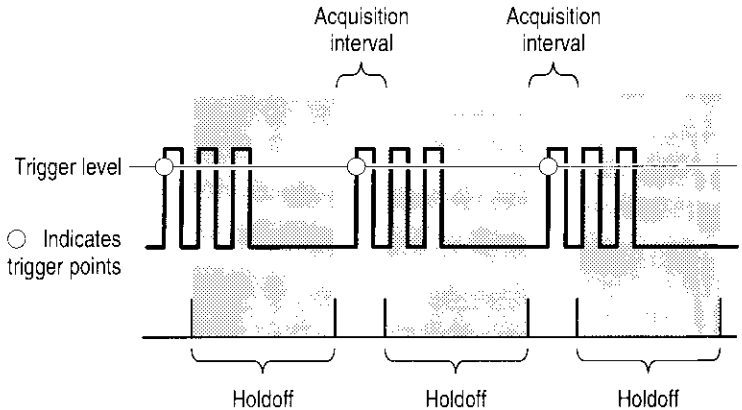







Triggers are not recognized during holdoff time.

NOTE. For best results, choose Normal trigger mode when using long holdoff settings (10 ms or greater).

Pulse Trigger

Use Pulse triggering to isolate and display specific events that you can qualify by time.

| | | | | |
|--|---|---|---|---|
|  METER  SCOPE |  |  |  |  |
| SCOPE | TRIGGER MENU | Trigger Type | Pulse | — |
| | | Trigger Source | Ch1 Ch2 | |
| | | Polarity & Width | Positive Negative | <i>Set width</i> |
| | | Trigger When | Less Than Width Greater Than Width | — |
| | | | Equal To Width Not Equal To Width | <i>Set ±%</i> |
| | | Mode & Holdoff | Auto Normal | — |

Key Points

Trigger Conditions. You can trigger on the following conditions:

- Less Than Width triggers on a pulse width that is less than the time threshold.
- Greater Than Width triggers on a pulse width that is greater than the time threshold.



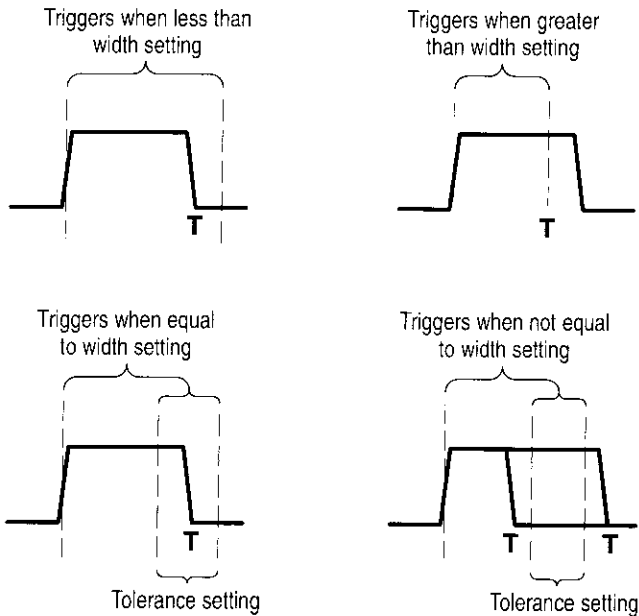

- Equal To Width triggers on a pulse that matches the set pulse width within a given tolerance. Use the +/- rocker to set the tolerance in percent. For example, if the pulse width is set to 1 μ s and the tolerance is set to $\pm 20\%$, triggering occurs only on pulse widths in the range from 800 ns to 1.2 μ s.
- Not Equal To Width triggers on a pulse that does not match the set pulse width and tolerance. Use the +/- rocker to set the tolerance.

Trigger Location. The T symbol shows where triggering occurs for the four trigger conditions.



Video Trigger

Choose video triggering to trigger on a specific line in the odd or even field, or on all the lines of an NTSC, PAL, or SECAM standard video signal. Also, you can trigger on nonstandard video signals with scan rates up to 65 kHz.







| | | | | |
|---|---|---|---|---|
|  |  |  |  |  |
| SCOPE | TRIGGER MENU | Trigger Type | Video | — |
| | | Trigger Source | Ch1 Ch2 | |
| | | Trigger On | Odd Field Even Field Any Field | <i>Set line number</i> |
| | | | Lines | — |
| | | Scan Rate | — | <i>Set scan rate</i> |
| | | Mode & Holdoff | Auto Normal | <i>Set holdoff</i> |

Key Points

Sync Pulses. When you choose Video, the trigger always occurs on negative-going sync pulses. If your video signal has positive-going sync pulses, invert the signal using the vertical menu. Refer to *VERTICAL Controls* on page 3–66 for information about inverting a signal.

Motor Trigger (THS720P)

Choose motor triggering to trigger on the rising or falling edge of a bipolar, motor drive waveform.

| | | | | |
|--|---|---|---|---|
|  METER  SCOPE |  |  |  |  |
| SCOPE | TRIGGER MENU | Trigger Type | Motor | — |
| | | Trigger Source | Ch1 Ch2 | |
| | | Trigger Coupling | DC AC | |
| | | Trigger Slope | / (rising edge) \ (falling edge) | |
| | | Mode & Holdoff | Auto Normal | |

Key Points

Trigger Level. You can set the trigger level from 0.1 to 5 divisions for positive slope, and from -0.1 to -5 divisions for negative slope. If you change the slope, the trigger level automatically changes sign.





UTILITY

The following are examples of what you can do with each of the six branches in the Utility menu:

- Use Config to display the firmware version.
- Use Hard Copy to set up hard copy parameters. Refer to *HARD COPY* on page 3–22 for information about setting up and printing a hard copy.
- Use RS-232 to set up for remote communication.
- Use Misc to set the standby or backlight timeout.
- Use Cal to compensate the signal path.
- Use Diag to run internal diagnostic routines.

Press the UTILITY button to display the utility menu. You can access the same utility menu from scope mode or meter mode. Then, use the left-most button in the utility menu to choose the branch. The remaining items in the utility menu may change depending on the branch you choose.

Config System







| | | | |
|--|---|---|---|
|  METER  SCOPE |  |  |  |
| SCOPE or METER | UTILITY | System | Config |
| | | Tek Secure Erase Memory | — |
| | | Version | |
| | | OK Erase Setup/Data | |

Key Points

Tek Secure. If you have acquired confidential data, you may want to execute Tek Secure before you return the TekScope instrument to general use. Executing Tek Secure accomplishes the following tasks:

- Replaces all waveforms (oscilloscope and data logger) in all reference memories with zero sample values
- Replaces the current front-panel setup and all stored setups with the factory setup
- Calculates the checksums of all waveform memory and setup memory locations to verify successful completion of waveform and setup erasure
- Displays a confirmation or warning message if the checksum calculation is successful or unsuccessful

RS-232 System







| | | | | |
|--|---|---|---|---|
|  METER  SCOPE |  |  |  |  |
| SCOPE or METER | UTILITY | System | RS-232 | — |
| | | Baud Rate | — | <i>Choose rate</i> |
| | | Flagging | Hard Flagging | On |
| | | | Soft Flagging | Off |
| | | Misc | EOL | CR LF CR/LF LF/CR |
| | | | Parity | None Even Odd |
| | | | Stop Bits | 1 2 |
| Delay | <i>Set delay</i> | | | |
| Set RS232 Parameters to Defaults | — | — | | |

Key Points

RS-232 Troubleshooting. If you are having RS-232 communication difficulties, try the following remedies:

- Verify that the RS-232 cable is connected to the correct port on your computer or hard copy device.
- Reset the RS-232 parameters to defaults and then set the baud rate to match the computer or hard copy device. The default settings (except baud rate) are standard on most computers and hard copy devices.

Misc System

| | | | | |
|--|---|---|---|---|
|  METER  SCOPE |  |  |  |  |
| SCOPE or METER | UTILITY | System | Misc | — |
| | | Power Off Time-Out | — | Set time |
| | | Backlight Time-Out | — | Set time |

Key Points





Power Off Time-Out. Use this feature to automatically turn off the TekScope instrument if it is not being used. Use the +/- rocker to set the power off time-out delay from one minute to 15 minutes or to ∞ (time-out off).

Power off time-out operates only when you use battery power.

Backlight Time-Out. Press this button to adjust the backlight time-out delay. This feature automatically turns the backlight off after a period of time if left unattended. Use the +/- rocker to set the backlight time-out delay from one minute to 15 minutes or to ∞ (time-out off).

Backlight time-out operates only when you use battery power.

Cal System

| | | | |
|---|---|--|---|
|  |  |  |  |
| <p>SCOPE or METER</p> | <p>UTILITY</p> | <p>System</p> | <p>Cal</p> |
| | | <p>Signal Path</p> | <p>—</p> |
| | | <p>Factory Scope</p> | |
| | | <p>Factory DMM</p> | |
| | | <p>OK Compensate Signal Path</p> <p>OK Factory Cal Scope</p> <p>OK Factory Cal DMM</p> | |





Key Points

Signal Path Compensation. Signal path compensation optimizes the oscilloscope accuracy for the current ambient temperature. For maximum accuracy, recompensate the signal path if the ambient temperature changes by 5° C or more.

To compensate the signal path, disconnect any probes or cables from the channel 1 and channel 2 input BNC connectors. Then, press the **Signal Path** and **OK Compensate Signal Path** buttons to confirm that you are ready to proceed. This procedure takes about one minute to complete.

Factory Scope and Factory DMM. Service personnel use these functions to calibrate the oscilloscope and DMM internal voltage references. Refer to your Tektronix field office or representative for assistance with these processes.

Diag System

| | | | |
|--|---|---|---|
|  METER  SCOPE |  |  |  |
| SCOPE or METER | UTILITY | System | Diag |
| | | Execute | — |
| | | Loop | Once Always Until Fail |
| | | Error Log | — |
| | | OK Run Test OK Display Log | |

Key Points

Starting Diagnostics. To execute the built-in diagnostic routines, disconnect all cables, probes, or leads from the oscilloscope and DMM inputs, and then press the **OK Run Test** button.

Stopping Diagnostics. Choose how you want the diagnostic routines to execute:

- Loop Once runs all diagnostic routines one time and then stops.
- Loop Always runs the diagnostic routines continuously. Press **HOLD** and then **CLEAR MENU** to resume normal operation.
- Loop Until Fail runs the diagnostic routines until the TekScope instrument fails a test or until you cycle the power.

Error Log. The error log contains summary data gathered over the life of the TekScope instrument and descriptions of the last 100 errors encountered. The last error in the list is the most recent. Press the +/- rocker to display subsequent pages of the error log.

VERTICAL Controls

You can use the vertical controls to display waveforms, adjust vertical scale and position, and set input parameters. In the THS720P TekScope instrument, the vertical controls are also used to display waveform harmonics. Refer to page 3–16 for a description of harmonics.

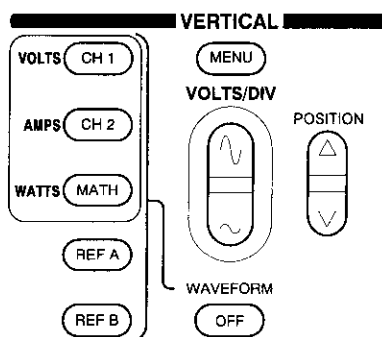

Vertical Operations in Scope Mode

All vertical operations affect the selected waveform. Press the CH 1, CH 2, MATH, REF A, or REF B button to select that waveform.







In harmonics mode (THS720P), the CH 1, CH 2, and MATH buttons display harmonics of voltage, current, and power waveforms.

To remove a waveform from the display, select the waveform and then press the WAVEFORM OFF button.

Press the MENU button to display the vertical menu. The contents of the vertical menu depend on which waveform is selected.

Channel 1 or Channel 2 Vertical Menu

The vertical menu contains the following items when channel 1 or channel 2 is the selected waveform.

|  METER  SCOPE |  |  |  |  |
|--|---|---|---|---|
| SCOPE | VERTICAL MENU | Coupling | DC AC GND | — |
| | | Invert | Invert Off Invert On | |
| | | Bandwidth | Full Bandwidth 20 MHz | |
| | | Position | — | |
| | | Probe Type | Current Probe | <i>Set conversion factor</i> |
| | | | Voltage Probe | <i>Set probe attenuation</i> |





Key Points

GND Coupling. Use GND coupling to display a zero-volt waveform. When you use GND coupling, the input BNC connector is disconnected from internal circuits. Internally, the channel input and its reference are connected to create a zero-volt reference level.

VOLTS/DIV Rocker. Use the VOLTS/DIV rocker to change the vertical sensitivity when acquisition is running. When acquisition is stopped, the rocker scales the waveform vertically.

Math Vertical Menu

The vertical menu contains the following items when Math is the selected waveform.

| | | | | |
|---|---|---|---|---|
|  |  |  |  |  |
| SCOPE | VERTICAL MENU | Math Operation | Ch1 + Ch2 Ch1 - Ch2 Ch2 - Ch1 Ch1 × Ch2 | — |

Key Points







Math Waveform Units. The waveform math function recognizes the following combinations of units.

| Channel 1 Unit | Channel 2 Unit | Math Operation | Resulting Math Unit |
|----------------|----------------|----------------|---------------------|
| V | V | + or - | V |
| A | A | + or - | A |
| V | V | × | VV |
| A | A | × | AA |
| V | A | × | W |
| A | V | × | W |

VOLTS/DIV Rocker. Use the VOLTS/DIV rocker to scale the waveform vertically. The rocker does not affect channel 1 or channel 2 sensitivity.

Ref A or Ref B Vertical Menu

The vertical menu contains the following items when Ref A or Ref B is the selected waveform.

| | | | | |
|---|---|---|---|---|
|  METER |  |  |  |  |
|  SCOPE | VERTICAL MENU | Save Ch1 | To Waveform | Choose waveform location |
| | | Save Ch2 | | |
| | | Save MATH | | |
| | | Horizontal Position | Lock Ind | — |
| | | OK Save Waveform | — | |







Key Points

Saving and Displaying a Waveform in One Step. You can copy a live waveform from one of the save sources shown above (Ch 1, Ch 2, or Math) into Ref A or Ref B for display and also into the nonvolatile storage location you choose with the +/- rocker.

Horizontal Position. Choose locked or independent horizontal position control for the reference waveforms.

- Choose Lock to position all displayed waveforms as a group.
- Choose Ind to position each reference waveform independently. The live waveforms (Ch 1, Ch 2, Math) still position as a group.

Vertical Operations in Meter Mode

|   |  |  |  |  |
|--|---|---|---|---|
| METER | VERTICAL MENU | Position | — | <i>Set position</i> |
| | | Zoom | Off 2X 5X 10X | — |
| | | Noise Reject | None 60 Hz 50 Hz | |
| | | Volts Scale | Volts | --- |
| | | | dB | <i>Set reference voltage</i> |
| | | | dBm into | <i>Set impedance</i> |
| | | Probe Type | Current Probe | <i>Set conversion factor</i> |
| Voltage Probe | — | | | |

Key Points

Zoom. You can get a close view of the data logger plot using the Zoom selection. The plot is vertically enlarged around the center of the screen for the VDC function, and around the bottom of the screen for other meter functions. Before you choose Zoom, you can choose Position or use the vertical POSITION rocker to move the plot.

Noise Reject. You can improve the repeatability of AC measurements in the presence of 50 Hz or 60 Hz noise by choosing noise rejection.

Volts Scale. If you choose dB, the current measurements, statistics, and logger data are shown in dB. If you choose dBm, you can set the impedance.

VOLTS/DIV Rocker. Use the VOLTS/DIV rocker to change the meter range and the vertical scale of the data logger plot.

POSITION Rocker. Use the vertical POSITION rocker to position the data logger plot.



Appendices

Appendix A: Specifications

This appendix contains the oscilloscope, DMM, and general specifications for the THS710A, THS720A, THS730A, and THS720P TekScope instruments. All specifications are guaranteed unless noted as “typical.” Typical specifications are provided for your convenience but are not guaranteed. Specifications that are marked with the ✓ symbol are checked in *Appendix D: Performance Verification*.

All specifications apply to all the TekScope instruments unless noted otherwise. All specifications assume horizontal MAG is off, unless noted otherwise. To meet specifications, two conditions must first be met:

- The TekScope instrument must have been operating continuously for ten minutes within the operating temperature range specified.
- You must perform the Compensate Signal Path operation described on page 2–11. If the operating temperature changes by more than 5° C, you must perform the Compensate Signal Path operation again.

Oscilloscope Specifications

| Acquisition | | |
|---------------------------|--|--|
| Acquisition Modes | Sample (Normal), Peak detect, Envelope, and Average | |
| Acquisition Rate, typical | Up to 25 waveforms per second (2 channels, sample acquisition mode, MAG on, no measurements) | |
| Single Sequence | <i>Acquisition Mode</i> | <i>Acquisition Stops After</i> |
| | Sample, Peak Detect | Single acquisition, one or two channels simultaneously |
| | Average, Envelope | N acquisitions, one or two channels simultaneously, N is settable from 2 to 256 or ∞ |

Oscilloscope Specifications (Cont.)

| Inputs | | |
|--|---|------------------------|
| Input Coupling | DC, AC, or GND | |
| Input Impedance, DC Coupled | 1 MΩ ±1% in parallel with 25 pF ±2 pF | |
| Maximum Voltage Between Signal and Common at Input BNC | <i>Overvoltage Category</i> | <i>Maximum Voltage</i> |
| | CAT II Environment (refer to page A-19) | 300 V _{RMS} |
| | CAT III Environment (refer to page A-19) | 150 V _{RMS} |
| | For steady-state sinusoidal waveforms, derate at 20 dB/decade above 100 kHz to 13 V _{pk} at 3 MHz and above. Also, refer to Overvoltage Category description on page A-19. | |
| Maximum Voltage Between Common and Earth Ground at BNC | 600 V _{RMS} (CAT II) or 300 V _{RMS} (CAT III), using rated connectors or accessories | |
| | 30 V _{RMS} , 42.4 V _{pk} , using noninsulated connectors or accessories | |
| Maximum Voltage, Channel-to-Channel Commons | 30 V _{RMS} , 42.4 V _{pk} , using noninsulated connectors or accessories | |
| Channel-to-Channel Common Mode Rejection, typical | 100:1 at frequencies ≤50 MHz, measured on MATH Ch1 – Ch2 waveform, with test signal applied between signal and common of both channels, and with the same VOLTS/DIV and coupling settings on each channel | |
| Channel-to-Channel Crosstalk, typical | ≥100:1 at 50 MHz, measured on one channel, with test signal applied between signal and common of the other channel, and with the same VOLTS/DIV and coupling settings on each channel | |
| Common to Chassis Capacitance, typical | 55 pF | |

Oscilloscope Specifications (Cont.)

| Vertical | | | | |
|---|--|---|---|--|
| Number of Channels | 2 | | | |
| Digitizers | 8 bit resolution, separate digitizers for each channel sample simultaneously | | | |
| VOLTS/DIV Range | 5 mV/div to 50 V/div at input BNC | | | |
| Polarity | Normal and Invert | | | |
| Position Range | ±10 divisions | | | |
| ✓ Analog Bandwidth at BNC, DC Coupled (typical at 5 mV/div; guaranteed at all other settings) | <i>THS710A</i> | <i>THS720A</i> | <i>THS720P</i> | <i>THS730A</i> |
| | 60 MHz at input BNC | 100 MHz at input BNC (90 MHz above 35° C) | 100 MHz at input BNC (90 MHz above 35° C) | 200 MHz at input BNC (180 MHz above 35° C) |
| Peak Detect or Envelope Bandwidth, typical (25 MS/s or slower) | <i>THS710A</i> | <i>THS720A</i> | <i>THS720P</i> | <i>THS730A</i> |
| | 50 MHz | 75 MHz | 75 MHz | 85 MHz |
| Analog Bandwidth Limit, typical | Selectable between 20 MHz or full | | | |
| Lower Frequency Limit, AC Coupled, typical | ≤10 Hz at BNC, reduced by a factor of ten when using a 10X passive probe | | | |
| Rise Time at BNC, typical | <i>THS710A</i> | <i>THS720A</i> | <i>THS720P</i> | <i>THS730A</i> |
| | 5.8 ns | 3.5 ns | 3.5 ns | 1.75 ns |
| Peak Detect or Envelope Pulse Response, typical | Captures 50% or greater amplitude of pulses ≥ 8 ns wide (≥ 20 ns wide at 500 ns/div) | | | |
| DC Gain Accuracy | ±2% for Sample or Average acquisition mode | | | |
| Position Accuracy | ±[0.4% × (position × volts/div) + (0.1 div × volts/div)] | | | |

Oscilloscope Specifications (Cont.)

| Vertical | | | | |
|---|---|---|---|--|
| ✓ DC Measurement Accuracy, Average Acquisition Mode Using ≥16 Waveforms | <i>Measurement Type</i> | | <i>Accuracy</i> | |
| | Absolute voltage measurements | | $\pm[2\% \times \text{Ireading} + (\text{position} \times \text{volts/div})] + (0.1 \text{ div} \times \text{volts/div})$ | |
| | Delta voltage between any two waveforms acquired under same setup | | $\pm[2\% \times \text{Ireading}] + (0.05 \text{ div} \times \text{volts/div})$ | |
| DC Measurement Accuracy, Sample Acq. Mode, typical | $\pm[2\% \times \text{Ireading} + (\text{position} \times \text{volts/div})] + (0.15 \text{ div} \times \text{volts/div}) + 0.6 \text{ mV}$ | | | |
| Horizontal | | | | |
| Sample Rate Range | <i>THS710A</i> | <i>THS720A</i> | <i>THS720P</i> | <i>THS730A</i> |
| | 5 S/s to 250 MS/s, in a 1.25, 2.5, 5 sequence | 5 S/s to 500 MS/s, in a 1.25, 2.5, 5 sequence | 5 S/s to 500 MS/s in a 1.25, 2.5, 5 sequence | 5 S/s to 1 GS/s in a 1.25, 2.5, 5 sequence |
| Record Length | 2500 samples for each channel | | | |
| SEC/DIV Range (including MAG) | <i>THS710A</i> | <i>THS720A</i> | <i>THS720P</i> | <i>THS730A</i> |
| | 10 ns/div to 50 s/div | 5 ns/div to 50 s/div | 5 ns/div to 50 s/div | 2 ns/div to 50 s/div |
| ✓ Sample Rate and Delay Time Accuracy | ±200 ppm over any ≥1 ms time interval | | | |
| Delay Time Range | Zero to 50 s | | | |

Oscilloscope Specifications (Cont.)

| Internal Trigger | | |
|--|--|---|
| ✓ Trigger Sensitivity, Edge Trigger Type (THS710A, THS 720A, and THS720P) | <i>Coupling</i> | <i>Sensitivity</i> |
| | DC | 0.35 div from DC to 50 MHz, increasing to 1 div at 100 MHz (90 MHz above 35° C) |
| ✓ Trigger Sensitivity, Edge Trigger Type (THS730A) | <i>Coupling</i> | <i>Sensitivity</i> |
| | DC | 0.35 div from DC to 50 MHz, increasing to 1.5 div at 200 MHz (180 MHz above 35° C) |
| Trigger Sensitivity, Edge Trigger Type, typical | <i>Coupling</i> | <i>Sensitivity</i> |
| | NOISE REJ | 3.5 times the DC-coupled limits |
| | HF REJ | 1.5 times the DC-coupled limit from DC to 30 kHz, attenuates signals above 30 kHz |
| | LF REJ | 1.5 times the DC-coupled limits for frequencies above 1 kHz, attenuates signals below 1 kHz |
| Trigger Level Range | ±4 divisions from center of screen | |
| Motor Trigger Level Range (THS720P) | 0.1 to 5 divisions from center of screen, polarity depends on slope selection | |
| Trigger Level Accuracy, typical | ±0.2 divisions, for signals having rise and fall times ≥20 ns | |
| SET LEVEL TO 50%, typical | Operates with input signals ≥50 Hz | |

Oscilloscope Specifications (Cont.)

| Internal Trigger | | |
|--|--|---|
| Width Range, Pulse Trigger Type, typical | 99 ns to 1 s, with resolution of 33 ns or approximately 1% of setting (whichever is greater) | |
| Width Tolerance Range, Pulse Trigger Type, typical | 5%, 10%, 15%, or 20% | |
| Sensitivity, Video Trigger Type, typical | Composite video signal with negative sync pulse amplitude from 0.6 to 2.5 divisions | |
| Signal Formats and Field Rates, Video Trigger Type | Broadcast systems | Supports NTSC, PAL, and SECAM |
| | Interlaced | Trigger on selected line of odd field, selected line of even field, or any line |
| | Noninterlaced | Trigger on selected line or any line |
| | Line Rates | 15 kHz to 65 kHz, in five ranges |
| Holdoff Range | 495 ns to 10 s | |

Oscilloscope Specifications (Cont.)

| External Trigger | |
|---|---|
| External Trigger, Maximum Input Voltage | 600 V _{RMS} CAT II, 300 V _{RMS} CAT III (refer to page A-19) |
| External Trigger Coupling | DC only |
| External Trigger Levels | +0.2 V or +2 V, selectable |
| External Trigger Sensitivity | 500 mV _{p-p} from DC to 1 MHz, increasing to 1 V _{p-p} at 5 MHz, with signal centered at selected trigger level. TTL compatible using +2 V trigger level. |
| Measurements | |
| Cursors | Voltage difference between cursors (ΔV) Time difference between cursors (ΔT) Reciprocal of ΔT in Hertz ($1/\Delta T$) Phase difference between cursors (Δ Degrees) |
| Automated Measurements | Amplitude, Burst Width, Cycle Mean, Cycle RMS, Fall Time, Frequency, High, Low, Max, Mean, Min, Negative Duty Cycle, Negative Overshoot, Negative Width, Pk - Pk, Period, Positive Duty Cycle, Positive Overshoot, Positive Width, Rise Time, and RMS |

Oscilloscope Specifications (Cont.)

| Voltage and Current Harmonics (THS720P) | | | | |
|--|---|---------------|---------------|---------------|
| Number of Harmonics | First 31 harmonics of signal with fundamental frequency between 30 Hz and 450 Hz | | | |
| Harmonics Amplitude Accuracy | Accuracies below are stated as a percent of the fundamental amplitude and are valid only if peak-to-peak amplitude is ≥ 4 divisions and number of averages ≥ 16 | | | |
| | <i>Fundamental</i> | 2 – 11 | 12 – 21 | 22 – 31 |
| | $\pm 2.5\%$ | $\pm 2.5\%$ | $\pm 4\%$ | $\pm 4\%$ |
| Harmonics Phase Accuracy | <i>Fundamental</i> | 2 – 11 | 12 – 21 | 22 – 31 |
| | — | $\pm 4^\circ$ | $\pm 8^\circ$ | $\pm 8^\circ$ |
| THD-F Measurement | Total harmonic distortion relative to the fundamental amplitude $THD-F = \frac{\sqrt{V_{RMS}^2 - V_f^2}}{V_f} \text{ or } \frac{\sqrt{A_{RMS}^2 - A_f^2}}{A_f}$ | | | |
| THD-F Accuracy | $\pm 4\%$ | | | |
| THD-R Measurement | Total harmonic distortion relative to the RMS amplitude $THD-R = \frac{\sqrt{V_{RMS}^2 - V_f^2}}{V_{RMS}} \text{ or } \frac{\sqrt{A_{RMS}^2 - A_f^2}}{A_{RMS}}$ | | | |
| THD-R Accuracy | $\pm 4\%$ | | | |
| Frequency Accuracy | $\pm 0.2\%$ of reading | | | |

Oscilloscope Specifications (Cont.)

| Power Measurements (THS720P) | |
|-------------------------------------|---|
| True Power Measurement | $W = \frac{1}{n} \times \sum_n V_n \times A_n$ <p><i>measured over an integral number of cycles that contain n sample points</i></p> |
| Apparent Power Measurement | $VA = V_{RMS} \times A_{RMS}$ |
| Reactive Power Measurement | $VAR = \sqrt{(VA)^2 - W^2}$ |
| Power Measurements Accuracy | ±4% at the BNCs (not including probe uncertainty) |
| PF Measurement | $\text{Power factor (PF)} = \frac{\text{true power}}{\text{apparent power}} = \frac{W}{VA}$ |
| θ Measurement | θ is the phase difference between the fundamental components of voltage and current. Positive angle means voltage leads current. Negative angle means voltage lags current. |
| DPF Measurement | <i>Displacement power factor (DPF) = cos θ</i> |
| Power Factor Measurements Accuracy | ±0.05 |

Oscilloscope Specifications (Cont.)**With P6117 Probe**

| | | | | |
|---|---|------------------------------------|------------------------------------|-------------------------------------|
| Analog Bandwidth, DC Coupled | <i>THS710A</i> | <i>THS720A</i> | <i>THS720P</i> | <i>THS730A</i> |
| | 60 MHz | 100 MHz (90 MHz above 35° C) | 100 MHz (90 MHz above 35° C) | 200 MHz (180 MHz above 35° C) |
| Probe Attenuation | 10X | | | |
| Maximum Voltage Between Probe Tip and Reference Lead | <i>Overvoltage Category</i> | | <i>Maximum Voltage</i> | |
| | CAT II Environment (refer to page A-19) | | 300 V _{RMS} | |
| | CAT III Environment (refer to page A-19) | | 150 V _{RMS} | |
| | For steady-state sinusoidal waveforms, derate at 20 dB/decade above 900 kHz to 13 V _{RMS} at 27 MHz and above. Also, refer to Overvoltage Category description on page A-19. | | | |
| Maximum Voltage Between Reference Lead and Earth Ground Using P6117 Probe | 30 V _{RMS} , 42.4 V _{pk} | | | |
| Maximum Voltage, Channel-to-Channel Reference Leads Using P6117 Probes | 30 V _{RMS} , 42.4 V _{pk} | | | |

Oscilloscope Specifications (Cont.)

| With P5102 Probe | | | | |
|---|---|------------------------------------|------------------------------------|----------------|
| Analog Bandwidth, DC Coupled | <i>THS710A</i> | <i>THS720A</i> | <i>THS720P</i> | <i>THS730A</i> |
| | 60 MHz | 100 MHz (90 MHz above 35° C) | 100 MHz (90 MHz above 35° C) | 100 MHz |
| Probe Attenuation | 10X | | | |
| Maximum Voltage Between Probe Tip and Reference Lead, DC Coupled | <i>Overvoltage Category</i> | | <i>Maximum Voltage</i> | |
| | CAT II Environment (refer to page A-19) | | 1000 V _{RMS} | |
| | CAT III Environment (refer to page A-19) | | 600 V _{RMS} | |
| Maximum Voltage Between Probe Tip and Reference Lead, AC Coupled | <i>Overvoltage Category</i> | | <i>Maximum Voltage</i> | |
| | CAT II Environment | | ±1000 V _{DC} | |
| | CAT III Environment | | ±600 V _{DC} | |
| Maximum Voltage Between Reference Lead and Earth Ground | <i>Overvoltage Category</i> | | <i>Maximum Voltage</i> | |
| | CAT II Environment | | 600 V _{RMS} | |
| | CAT III Environment | | 300 V _{RMS} | |

DMM Specifications**General**

| | | |
|---|--|---|
| Resolution | 3 ³ / ₄ digit, 4000 count full scale reading except as noted | |
| Input Resistance, AC or DC Voltage | 10 M Ω \pm 10% | |
| Input Capacitance, AC or DC Voltage, typical | \leq 100 pF | |
| Maximum Voltage Between DMM and COM Inputs | <i>Overvoltage Category</i> | <i>Maximum Voltage</i> |
| | CAT I Environment (refer to page A-19) | 640 V _{RMS} (880 V _{DC}) |
| | CAT II Environment (refer to page A-19) | 600 V _{RMS} |
| | CAT III Environment (refer to page A-19) | 300 V _{RMS} |
| Maximum Voltage Between DMM or COM Input and Earth Ground | <i>Overvoltage Category</i> | <i>Maximum Voltage</i> |
| | CAT I Environment (refer to page A-19) | 640 V _{RMS} (880 V _{DC}) |
| | CAT II Environment (refer to page A-19) | 600 V _{RMS} |
| | CAT III Environment (refer to page A-19) | 300 V _{RMS} |

DC Voltage

| Ranges and Resolution | Range | Resolution |
|-----------------------|----------|------------|
| | 400.0 mV | 0.1 mV |
| | 4.000 V | 1 mV |
| | 40.00 V | 10 mV |
| | 400.0 V | 100 mV |
| | 880 V | 1 V |

DMM Specifications (Cont.)

| DC Voltage | | |
|--------------------------------|---|-----------------------------|
| ✓ Accuracy | ±(0.5% of reading + 5 counts) | |
| Normal Mode Rejection, typical | Rejects AC signals by >60 dB at 50 Hz or 60 Hz (user selectable) | |
| Common Mode Rejection, typical | Rejects AC signals by >100 dB at 50 Hz or 60 Hz (user selectable) | |
| AC Voltage | | |
| Conversion Type | AC conversions are true RMS. The AC measurement is based on the AC and DC components of the signal as shown below: <i>AC Measurement = RMS(AC+DC) – DC</i> | |
| Ranges and Resolution | <i>Range</i> | <i>Resolution</i> |
| | 400.0 mV | 0.1 mV |
| | 4.000 V | 1 mV |
| | 40.00 V | 10 mV |
| | 400.0 V | 100 mV |
| | 640 V | 1 V |
| ✓ Accuracy (40 Hz to 500 Hz) | <i>Input Waveform</i> | <i>Maximum Error</i> |
| | Sinusoidal waveforms with no DC component | ±(2% of reading + 5 counts) |
| | Nonsinusoidal waveforms with crest factor up to 3 and no DC component | ±(4% of reading + 5 counts) |
| Common Mode Rejection, typical | Rejects AC signals by >60 dB at DC, 50 Hz, and 60 Hz | |

DMM Specifications (Cont.)

| Ω/Resistance | | |
|---|---------------------------------|--|
| Ranges and Resolution | <i>Range</i> | <i>Resolution</i> |
| | 400.0 Ω | 0.1 Ω |
| | 4.000 k Ω | 1 Ω |
| | 40.00 k Ω | 10 Ω |
| | 400.0 k Ω | 100 Ω |
| | 4.000 M Ω | 1 k Ω |
| | 40.00 M Ω | 10 k Ω |
| ✓ Accuracy | <i>Range</i> | <i>Maximum Error</i> |
| | All ranges except 40 M Ω | $\pm(0.5\%$ of reading + 2 counts) |
| | 40 M Ω | $\pm(2\%$ of reading + 5 counts) for $\leq 60\%$ relative humidity |
| Bias Voltage for Full Scale Resistance Measurement, typical | <i>Range</i> | <i>Full Scale Bias Voltage</i> |
| | 400.0 Ω | 350 mV |
| | 4.000 k Ω | 200 mV |
| | 40.00 k Ω | 350 mV |
| | 400.0 k Ω | 350 mV |
| | 4.000 M Ω | 400 mV |
| | 40.00 M Ω | 1.10 V |
| Open Circuit Voltage, typical | <i>Range</i> | <i>Open Circuit Voltage</i> |
| | 400.0 Ω | 4.8 V |
| | All other ranges | ≤ 1.2 V |

DMM Specifications (Cont.)

| Continuity Check | |
|-------------------------------|--|
| Indication, typical | An audible tone is generated when measured resistance is below 50 Ω |
| Open Circuit Voltage, typical | 4 V |
| Test Current, typical | 1 mA |
| Diode Check | |
| Range | Zero to 2 V, measures forward voltage drop of semiconductor junction |
| Voltage Accuracy, typical | $\pm 25\%$ |
| Open Circuit Voltage, typical | 4 V |
| Test Current, typical | 1 mA |
| Data Logger | |
| Horizontal Scale Range | 30 s/div to 24 hours/div (4 minutes to 8 days, full scale) |
| Vertical Zoom Range | 2X, 5X, or 10X |

General Specifications

| Display | |
|------------------------------|---|
| Display Type | 4.7 in (120 mm) diagonal liquid crystal |
| Display Resolution | 320 horizontal by 240 vertical pixels |
| Display Contrast | Adjustable, temperature compensated |
| Backlight Intensity, typical | 35 cd/m ² |

General Specifications (Cont.)**RS-232 Interface**

| Device Type | DTE, at RJ-45 connector | | |
|-------------|-------------------------|---|--------------------------------------|
| Pinout | <i>Signal</i> | <i>Pin Number at 9-pin Null Modem Adapter</i> | <i>Pin Number at RJ-45 Connector</i> |
| | RTS out | 1 | 8 |
| | TXD out | 2 | 6 |
| | RXD in | 3 | 5 |
| | GND | 5 | 4 |
| | DTR out | 6 | 3 |
| | CTS in | 7 | 7 |
| | RTS out | 8 | 8 |
| | DSR in (not used) | 4 | 2 |
| | DCD in (not used) | 7 | 1 |

Probe Compensator Output

| | |
|-------------------------|--|
| Output Voltage, typical | 5.0 V into $\geq 1 \text{ M}\Omega$ load |
| Frequency, typical | 1.2 kHz |

General Specifications (Cont.)

| Power Source | | |
|---------------------------------|--|-----------|
| Battery | Replaceable Ni-Cd battery pack | |
| Battery Life, typical | Approximately two hours of continuous use from a full charge | |
| Low Battery Indication, typical | Low battery message first appears approximately ten minutes before the instrument powers off automatically | |
| Battery Saver | Standby Time-out and Backlight Time-out extend battery life. Time-out ranges from 1 minute to 15 minutes, or off. | |
| Battery Charging Time, typical | With TekScope instrument operating | 9 hours |
| | With TekScope instrument turned off | 9 hours |
| | In external charger | 1.5 hours |
| External Power | 12 VDC nominal, center positive; Operates with input from 10 VDC to 15 VDC The DC INPUT disconnects itself automatically if >15 VDC is applied. If this occurs, disconnect the overvoltage and then reconnect to a voltage in the proper range. | |
| Memory Retention, typical | All memory is retained indefinitely with battery removed and without external power applied. | |
| Fuse | This instrument has no user-replaceable fuses | |

General Specifications (Cont.)

| Environmental | | |
|--------------------------|---|--|
| Temperature | Operating | -10° C to +50° C |
| | Nonoperating | -20° C to +60° C |
| Humidity | +40° C or below | ≤95% relative humidity |
| | +41° C to +50° C | ≤75% relative humidity |
| Altitude | Operating | 2,000 m |
| | Nonoperating | 15,000 m |
| Random Vibration | Operating | 2.66 g _{RMS} from 5 Hz to 500 Hz, 10 minutes on each axis |
| | Nonoperating | 3.48 g _{RMS} from 5 Hz to 500 Hz, 10 minutes on each axis |
| Drop Resistance, typical | Survives a 30 in (76 cm) drop onto concrete with only cosmetic damage | |
| Moisture Resistance | Meets IEC529, IP43 with DC input hole plug, I/O port hole plug, and battery door installed. | |

General Specifications (Cont.)

| Mechanical | | |
|---------------------------------------|--|--|
| Size | Height | 8.53 in (217 mm) |
| | Width | 6.95 in (177 mm) |
| | Depth | 2.00 in (50.8 mm) |
| Weight | With battery installed | 3.2 lbs (1.5 kg) |
| | With all standard accessories in soft carry case | 7.5 lbs (3.4 kg) |
| | When packaged for domestic shipment | 9.0 lbs (4.1 kg) |
| Certifications and Compliances | | |
| Certifications | Listed UL3111-1 and CAN/CSA-C22.2 No. 1010.1-92, complies with EN61010-1 /A2 | |
| Overvoltage Category | <i>Category</i> | <i>Examples</i> |
| | CAT III | A typical CAT III environment is the power distribution system within a building or factory. These environments are somewhat protected from lightning strikes, but susceptible to switching transients and other disturbances that may generate high voltage impulses. |
| | CAT II | A typical CAT II environment is the 120/240 V distribution system within a lab or office. These environments are fairly well protected from external high voltage disturbances. |
| | CAT I | A typical CAT I environment is circuitry inside electrical or electronic equipment that is powered by a power supply or a battery. |

General Specifications (Cont.)

Certifications and Compliances

EC Declaration of Conformity

Meets the intent of Directive 89/336/EEC for Electromagnetic Compatibility and Low-Voltage Directive 73/23/ECC for Product Safety as amended by 93/68/EEC. Compliance was demonstrated to the following specifications as listed in the official Journal of the European Communities:

EN 55011 Class A: Radiated and Conducted Emissions^{1 3}

EN 50081-1 Emissions:
EN 60555-2 Power Harmonics

EN 50082-1 Immunity:
IEC 801-2 Electrostatic Discharge
IEC 801-3 RF Radiated²
IEC 801-4 Fast Transients
IEC 801-5 Surge³

EN 61010-1 /A2 Safety

- ¹ Tektronix-supplied ferrite bead required on instrument end of RS-232 cable
- ² Performance criteria: ≤ 5.0 div increase in peak-to-peak noise (Sample acquisition mode, full bandwidth); otherwise, ≤ 1.0 div increase in peak-to-peak noise
- ³ Applies to instrument operating from Tektronix-supplied AC adapter

Adjustment Interval

The recommended adjustment interval is one year

Appendix B: Factory Setup

The table below lists the state of the TekScope instrument after you recall the Factory Setup.

| Control | Changed by Factory Setup to |
|-------------------------------------|--------------------------------|
| Acquire mode | Sample |
| Acquire stop after | HOLD button only |
| Acquire # of averages | 16 |
| Acquire # of envelopes | 8 |
| Channel selection | Channel 1 on, all others off |
| Cursor H Bar 1 position | -3.2 divisions from the center |
| Cursor H Bar 2 position | +3.2 divisions from the center |
| Cursor V Bar 1 position | -2 divisions from the center |
| Cursor V Bar 2 position | +2 divisions from the center |
| Cursor function | Off |
| Cursor time units | Seconds |
| Delayed time base time/div | 50 μ s/div |
| Delay time, delayed runs after main | 200 ns |
| Data logger position | 0 V |
| Data logger rate | 30 s/div |
| Data logger zoom | Off |
| dB reference voltage | 1 V |
| dBm into impedance | 50 Ω |
| Display format | YT |
| Display graticule type | Full |
| Display contrast | 50% |

| Control | Changed by Factory Setup to |
|------------------------------------|------------------------------------|
| Display style | Vectors |
| Display trigger "T" | On |
| Display accumulate time | 500 ms |
| DMM mode – autorange | Off |
| DMM function | DC volts |
| DMM mode – scope on/off | Off |
| Edge trigger coupling | DC |
| Edge trigger level | 0.0 V |
| Edge trigger slope | Rising |
| Edge trigger source | Channel 1 |
| Harmonics (THS720P) | Off |
| Horizontal – main trigger position | 50% |
| Horizontal – Mag | Off |
| Horizontal – time base | Main only |
| Main time base time/div | 500 μ s/div |
| Math waveform function | CH1 + CH2 |
| Measure High-Low Setup | Histogram |
| Saved setups | No change |
| Saved waveforms | No change |
| Scope/DMM mode | Scope mode |
| Scope mode – autorange | Off |
| Scope mode – meter on/off | On |
| Trigger holdoff | Minimum (495 ns) |
| Trigger mode | Auto |

| Control | Changed by Factory Setup to |
|------------------------------------|------------------------------------|
| Trigger type | Edge |
| Vertical bandwidth (all channels) | Full |
| Vertical coupling (all channels) | DC |
| Vertical position (all channels) | 0 div |
| Vertical volts/div. (all channels) | 100 mV/div |
| Volts scale | Volts |

Appendix C: Accessories

Standard Accessories

P6117 10X Passive Probes (THS730A, THS720A, and THS710A)

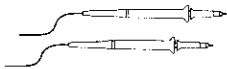

The P6117 10X passive probes have 200 MHz bandwidth and a CAT II voltage rating of 300 V_{RMS}. These probes are suitable for floating measurements up to 30 V_{RMS}.

P5102 10X Passive Probes (THS720P)

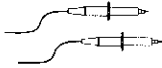

The P5102 10X passive probes have 100 MHz bandwidth and a CAT II voltage rating of 1000 V_{RMS}. These probes are suitable for floating measurements up to 600 V_{RMS}.

Meter Lead Set

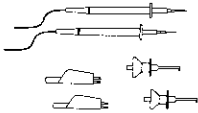

The standard pair of meter leads (012-1482-00) provides sharp tips for probing, two screw-on plunger tips for grabbing test points or small conductors, and two screw-on insulated alligator clips for grabbing terminals or larger conductors.

Battery Pack



The TekScope instrument includes one high-capacity (4.8 V, 2.8 A-hr), rechargeable battery pack. Refer to THS7BAT on page C-3.

AC Power Adapter



The AC power adapter allows operation from the AC power line and charges the internal battery. (North American 119-4812-XX, Universal European 119-4813-XX, United Kingdom 119-4922-XX, Japan 119-4923-XX)

Standard Accessories (Cont.)

RS-232 Cable and Adapter



This RS-232 cable set includes a 2 m cable (012-1364-00) with RJ-45 connectors on each end. The set also includes a 9-pin adapter (103-0403-00) to connect to PCs.

Soft Case

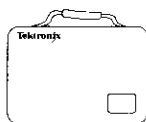

The soft case (016-1399-01) protects the TekScope instrument when not in use. The soft case provides compartments for probes, one spare battery, AC power adaptor, and the User Manual.

Manual

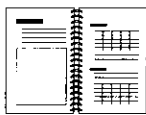

The TekScope instrument includes one User Manual (070-9731-XX) and one Reference (070-9741-XX).

Optional Accessories

P5102 10X Passive Probes (THS730A, THS720A, and THS710A)

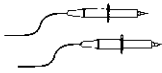

The P5102 10X passive probes have 100 MHz bandwidth and a CAT II voltage rating of 1000 V_{RMS}. These probes are suitable for floating measurements up to 600 V_{RMS}.

Deluxe Meter Lead Set

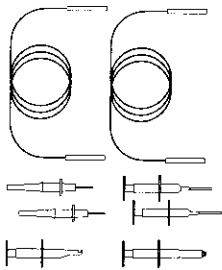

The deluxe pair of meter leads (ATLDX1) uses a sheathed banana-jack interface that is compatible with a variety of probing accessories. The deluxe set includes two sharp tips for probing, two plunger tips for grabbing component leads, one plunger tip for grabbing test points or small conductors, and one plunger tip with crocodile jaws for grabbing terminals or larger conductors. The cables have heat-resistant silicone insulation.

THS7CHG Battery Charger

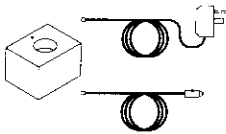

The battery charger recharges the battery pack in 1.5 hours. It can be powered from AC power or from the 12 V from an automobile cigarette lighter.

THS7BAT Extra Rechargeable Battery Pack



An extra rechargeable battery pack provides a high-capacity (4.8 V, 2.8 A-hr), spare battery for extended portable operation.

Optional Accessories (Cont.)

Cigarette Lighter Adapter



The cigarette lighter adapter (174-1734-00) allows you to operate the TekScope instrument or charge the internal battery from an automobile cigarette lighter.

HC 411 Thermal Printer

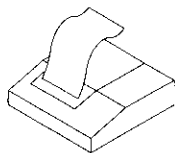

The HC 411 is a lightweight, portable, thermal printer that operates from AC or battery power and prints on 112 mm (4.4 in) wide paper. Additional paper is available; order part number 006-7580-00 for a package of five rolls.

THS7HCA Hard Carrying Case

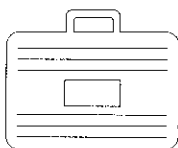

The hard carrying case provides ultimate protection for the TekScope instrument. This case has room for the TekScope instrument, voltage probes, meter leads, current probes, AC power adapter, battery charger, spare battery, and manuals.

A621 and A622 Current Probes

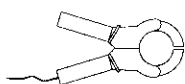

Two Tektronix current probes extend the TekScope instrument to handle current and power measurements. These clamp-on probes do not require disconnections to insert them into the circuit. Both current probes have BNC connectors for the oscilloscope channels and include safety banana-jack adapters for use with the DMM.

A621: AC only, 2,000 A max, 5 Hz to 50 kHz, selectable output at 1, 10, or 100 mV/A.

A622: AC or DC, 100 A max, DC to 100 kHz, selectable output at 10 or 100 mV/A.

Optional Accessories (Cont.)

A605 and A610 Current Probes

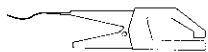

These busbar-style current probes have banana plug connectors to measure current using the DMM.

A605: AC only, 500 A max, 48 Hz to 1 kHz, 1 mV/A

A610: AC or DC, 500 A max, DC to 440 Hz, 1 mV/A

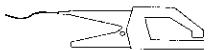

P6408 Word Recognizer Trigger Probes

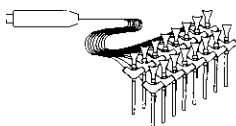

The P6408 is a 16-bit word recognizer probe for TTL logic operating at clock rates up to 20 MHz. This probe is used for trigger event recognition only, not logic signal display.

WSTR31 WaveStar Software



WaveStar is a Windows application that helps interface the TekScope instrument to your PC. You can upload and download waveforms and setups. You can export acquired data to spreadsheets for further analysis, to word processors to integrate with your documentation, or to printers and plotters to make hard copies.

Manuals

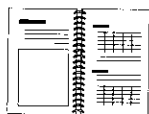

Programmer Manual (070-9751-XX) provides information about remote-control operation.

Service Manual (070-9752-XX) provides information about maintenance and module-level repair.

Appendix D: Performance Verification

This appendix contains performance verification procedures for the specifications marked with the ✓ symbol. The following equipment, or a suitable equivalent, is required to complete these procedures.

| Description | Minimum Requirements | Examples |
|---------------------------------------|--|--|
| DC Voltage Source | 60 mV to 800 V, $\pm 0.1\%$ accuracy | Wavetek 9100 Universal Calibration System with Oscilloscope Calibration Module (Option 250) Fluke 5500A Multi-product Calibrator with Oscilloscope Calibration Option (Option 5500A-SC) |
| AC Voltage Source | 300 mV to 640 V, $\pm 0.5\%$ accuracy at 500 Hz | |
| Resistance Standard | 360 Ω to 36 M Ω , $\pm 0.1\%$ accuracy | |
| Leveled Sine Wave Generator | 50 kHz to 200 MHz, $\pm 3\%$ amplitude accuracy | |
| Time Mark Generator | 10 ms period, ± 50 ppm accuracy | |
| Banana to Banana Cable (two required) | Shielded banana jacks on each end | Tektronix Deluxe Meter Lead Set (ATLDX1) |
| 50 Ω BNC Cable | BNC male to BNC male, ≈ 36 in (1 m) long | Tektronix part number 012-0482-XX |
| 50 Ω Feedthrough Termination | BNC male and female connectors | Tektronix part number 011-0049-XX |
| Dual Banana to BNC Adapter | Banana plugs to BNC female | Tektronix part number 103-0090-XX |

Test Record

| Serial Number | Procedure Performed by | Date |
|---------------|------------------------|------|
| | | |

| Test | Passed | Failed |
|-----------|--------|--------|
| Self Test | | |

| Oscilloscope Tests | | Low Limit | Test Result | High Limit |
|--------------------------------------|------------|----------------|-------------|------------|
| Channel 1 DC Measurement Accuracy | 5 mV/div | 34.05 mV | | 35.95 mV |
| | 500 mV/div | 3.405 V | | 3.595 V |
| | 2 V/div | 13.62 V | | 14.38 V |
| | 10 V/div | 68.1 V | | 71.9 V |
| Channel 2 DC Measurement Accuracy | 5 mV/div | 34.05 mV | | 35.95 mV |
| | 500 mV/div | 3.405 V | | 3.595 V |
| | 2 V/div | 13.62 V | | 14.38 V |
| | 10 V/div | 68.1 V | | 71.9 V |
| Channel 1 Bandwidth | | 425 mV | | — |
| Channel 2 Bandwidth | | 425 mV | | — |
| Sample Rate and Delay Time Accuracy | | -4 divs | | +4 divs |
| Channel 1 Edge Trigger Sensitivity | | Stable trigger | | — |
| Channel 2 Edge Trigger Sensitivity | | Stable trigger | | — |

| DMM Tests | | Low Limit | Test Result | High Limit |
|---------------------|--|------------------|-------------|------------------|
| DC Voltage Accuracy | 400 mV range, 60 mV input | 59.2 mV | | 60.8 mV |
| | 400 mV range, 360 mV input | 357.7 mV | | 362.3 mV |
| | 4 V range | 3.577 V | | 3.623 V |
| | 40 V range | 35.77 V | | 36.23 V |
| | 400 V range | 357.7 V | | 362.3 V |
| | 880 V range | 783 V | | 801 V |
| AC Voltage Accuracy | 400 mV range | 352.3 mV | | 367.7 mV |
| | 4 V range, 600 mV input | 0.583 V | | 0.617 V |
| | 4 V range, 3.6 V input | 3.523 V | | 3.677 V |
| | 40 V range | 35.23 V | | 36.77 V |
| | 400 V range | 352.3 V | | 367.7 V |
| | 640 V range | 559 V | | 593 V |
| Resistance Accuracy | 400 Ω range | 358.0 Ω | | 362.0 Ω |
| | 4 k Ω range | 3.580 k Ω | | 3.620 k Ω |
| | 40 k Ω range, 6 k Ω input | 5.95 k Ω | | 6.05 k Ω |
| | 40 k Ω range, 36 k Ω input | 35.80 k Ω | | 36.20 k Ω |
| | 400 k Ω range | 358.0 k Ω | | 362.0 k Ω |
| | 4 M Ω range | 3.580 M Ω | | 3.620 M Ω |
| | 40 M Ω range | 35.23 M Ω | | 36.77 M Ω |

Performance Verification Procedures

Before beginning these procedures, two conditions must first be met:

- The TekScope instrument must have been operating continuously for ten minutes in an 18° C to 28° C ambient environment with a relative humidity of less than 60%.
- You must perform the Compensate Signal Path operation described on page 2–11. If the operating temperature changes by more than 5° C, you must perform the Compensate Signal Path operation again.





The time required to complete the entire procedure is approximately one hour.



WARNING. *Some procedures use hazardous voltages. To prevent electrical shock, always set voltage source outputs to 0 V before making or changing any interconnections.*

Self Test

This procedure uses internal routines to verify that the TekScope instrument functions and passes its internal self tests. No test equipment or hookups are required. Start the self test with the following setup:

| | | | |
|---|---|---|---|
|  |  |  |  |
| SCOPE | UTILITY | System | Diag |
| | | Loop | Once |
| | | Execute | — |
| | | OK Run Test | |

A dialog box displays the result when the self test completes. Press the **CLEAR MENU** button to continue operation.



Check DC Measurement Accuracy

1. Set the DC voltage source output level to **0 V**.
2. Set up the TekScope instrument using the following steps:

| | | | | |
|----------------|----------------|---|----------------------|-----------|
| METER SCOPE | METER SCOPE | | | TOGGLE |
| SCOPE | SAVE/RECALL | Recall Saved Setup OK Recall Factory | Recall Factory Setup | — |
| | CH 1 | — | — | |
| | VERTICAL MENU | Probe Type | Voltage Probe | Set to 1X |
| | ACQUIRE | Acquire Mode | Average | Set to 16 |
| | MEAS | Select Measmnt | Mean* | — |
| | | OK Select Measmnt | — | |

* You may need to press **Select Page** to display this selection.

3. Connect the TekScope instrument to the DC voltage source as shown below.

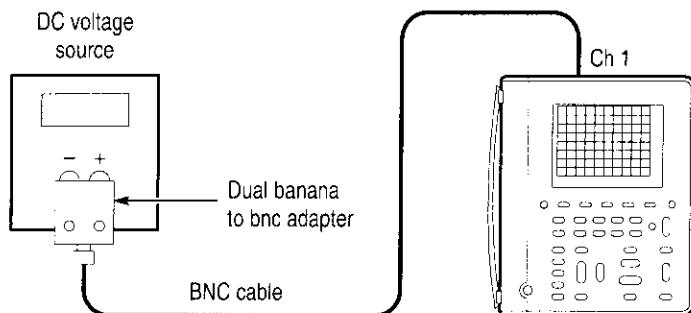

4. For each VOLTS/DIV setting listed below, perform the following steps:
 - a. Set the DC voltage source output level to the positive voltage listed and then record the mean measurement as V_{pos} .
 - b. Reverse the polarity of the DC voltage source and then record the mean measurement as V_{neg} .
 - c. Calculate $V_{\text{diff}} = V_{\text{pos}} - V_{\text{neg}}$ and then compare V_{diff} to the accuracy limits in the table.

| VOLTS/DIV Setting | DC Voltage Source Output Levels | Accuracy Limits for V_{diff} |
|-------------------|---------------------------------|---------------------------------------|
| 5 mV/div | +17.5 mV, -17.5 mV | 34.05 mV to 35.95 mV |
| 500 mV/div | +1.75 V, -1.75 V | 3.405 V to 3.595 V |
| 2 V/div | +7.00 V, -7.00 V | 13.62 V to 14.38 V |
| 10 V/div | +35.0 V, -35.0 V | 68.1 V to 71.9 V |

5. Set DC voltage source output level to **0 V**.
6. To check channel 2, repeat step 2 substituting CH 2 for CH 1.
7. Press **CH 1** and **WAVEFORM OFF** to remove the channel 1 waveform from the display.
8. Repeat steps 3 through 5, substituting CH 2 for CH 1, to complete the check of channel 2.



Check Channel 1 Bandwidth

1. Set up the TekScope instrument using the following steps:

| | | | | | | |
|-------|-----------------|---|----------------------------------|---|-----------|---|
| | | | | | | |
| SCOPE | SAVE/ RECALL | Recall Saved Setup OK Recall Factory | Recall Factory Setup — | — | — | — |
| | ACQUIRE | Acquire Mode | Average | — | Set to 16 | — |
| | TRIGGER | Trigger Coupling | Noise Reject | — | — | — |
| | MEAS | High-Low Setup | Min-Max | — | — | — |
| | | Select Measmnt | PK-Pk* | — | — | — |
| | | OK Select Measmnt | — | — | — | — |

* You may need to press Select Page to display this selection.

2. Connect the TekScope instrument to the leveled sine wave generator as shown below.

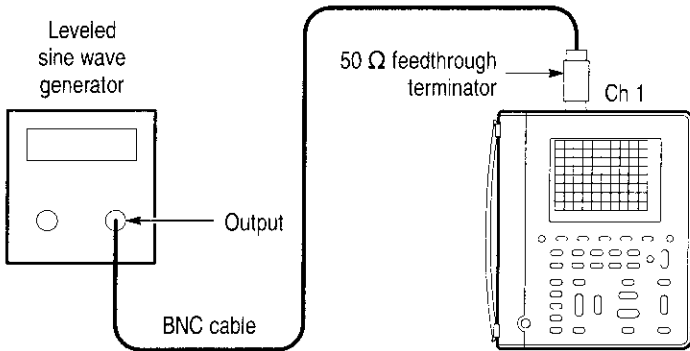

3. Set the TekScope instrument VOLTS/DIV to **100 mV/div**.
4. Set the TekScope instrument SEC/DIV to **10 μ s/div**.
5. Set the leveled sine wave generator frequency to **50 kHz**.
6. Set the leveled sine wave generator output level so the peak-to-peak measurement is between **599 mV** and **601 mV**.
7. Set the leveled sine wave generator frequency to **200 MHz** if you are checking a THS730A, **100 MHz** if you are checking a THS720A or a THS720P, or **60 MHz** if you are checking a THS710A.
8. Press **MAG**.
9. Set the TekScope instrument SEC/DIV to **10 ns/div**.
10. Check that the peak-to-peak measurement is \geq **425 mV**.
11. Press **MAG**.
12. Proceed to the next test to check the channel 2 bandwidth.



Check Channel 2 Bandwidth

1. First check the channel 1 bandwidth using the previous test. Then, perform these additional steps to check the channel 2 bandwidth:

| | | | |
|----------------|--------------|-------------------|---------|
| METER SCOPE | MULTIPLIER | | |
| SCOPE | CH 1 | — | — |
| | WAVEFORM OFF | | |
| | CH 2 | | |
| | TRIGGER | Trigger Source | Ch2 |
| | MEAS | High-Low Setup | Min-Max |
| | | Select Measrmt | Pk-Pk* |
| | | OK Select Measrmt | — |

* You may need to press **Select Page** to display this selection.

2. Connect the TekScope instrument to the leveled sine wave generator as shown below.

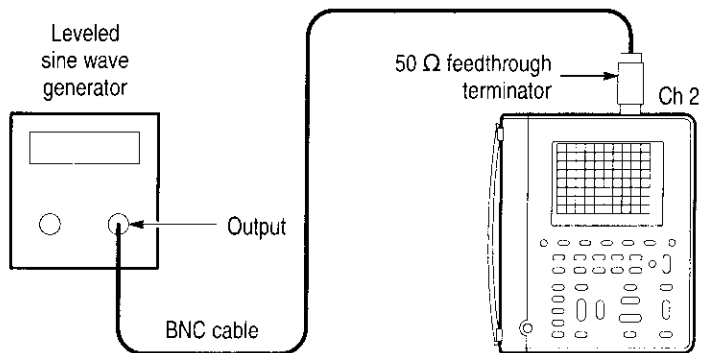







3. Set the TekScope instrument VOLTS/DIV to **100 mV/div**.
4. Set the TekScope instrument SEC/DIV to **10 μ s/div**.
5. Set the leveled sine wave generator frequency to **50 kHz**.
6. Set the leveled sine wave generator output level so the peak-to-peak measurement is between **599 mV** and **601 mV**.
7. Set the leveled sine wave generator frequency to **200 MHz** if you are checking a THS730A, **100 MHz** if you are checking a THS720A or a THS720P, or **60 MHz** if you are checking a THS710A.
8. Press **MAG**.
9. Set the TekScope instrument SEC/DIV to **10 ns/div**.
10. Check that the peak-to-peak measurement is \geq **425 mV**.



Check Sample Rate and Delay Time Accuracy

1. Set up the TekScope instrument using the following steps:



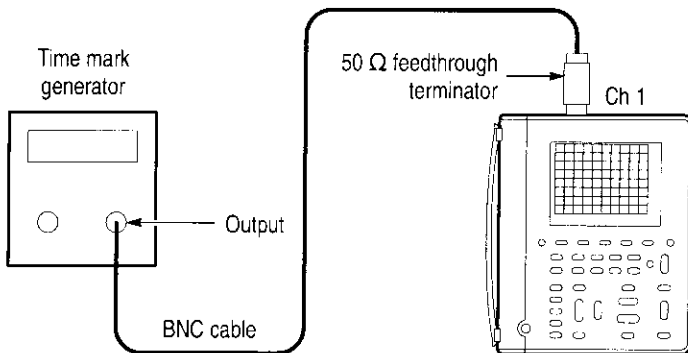

| | | | | |
|---|---|---|---|--|
|  METER |  |  |  | TOGGLE  |
|  SCOPE | SAVE/ RECALL | Recall Saved Setup | Recall Factory Setup | — |
| | | OK Recall Factory | — | |
| | VERTICAL MENU | Probe Type | Voltage Probe | Set to 1X |

2. Connect the TekScope instrument to the time mark generator as shown below.







3. Set the time mark generator period to **10 ms**.
4. Set the TekScope instrument VOLTS/DIV to **500 mV/div**.
5. Use the vertical POSITION rocker to center the test signal on screen.

6. Press **SET LEVEL TO 50%**.
7. Press **MAG**.
8. Change the TekScope instrument setup using the following steps:

| | | | | |
|---|---|---|---|---|
|  |  |  |  |  |
| SCOPE | HORIZON- TAL MENU | Time Base | Delayed Runs After Main | — |
| | CLEAR MENU | — | — | |

9. Set the delayed time base to **50 ms/div**.
10. Change the TekScope instrument setup using the following steps:

| | | | | |
|---|---|---|---|---|
|  |  |  |  |  |
| SCOPE | HORIZON- TAL MENU | Time Base | Delayed Runs After Main | Set delay time to 10 ms |
| | CLEAR MENU | — | — | — |

11. Set the delayed time base SEC/DIV to **500 ns/div**.
12. Check that the rising edge of the marker crosses the center horizontal graticule line within ± 4 divisions of center graticule.

NOTE. One division of displacement from graticule center corresponds to a 50 ppm time base error.



Check Channel 1 Edge Trigger Sensitivity

1. Set up the TekScope instrument using the following steps:



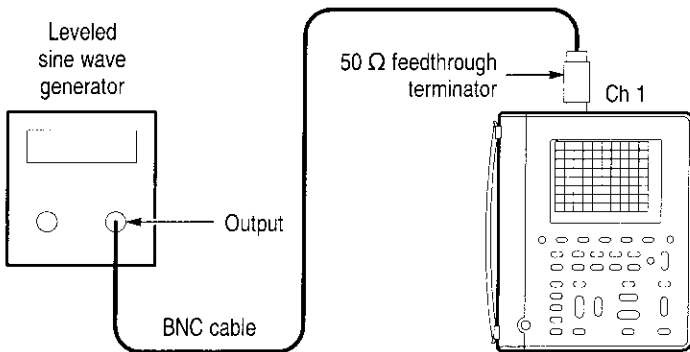

| | | | | | |
|-------|-----------------|--------------------|----------------------|------------------|--------|
| | METER | | | | TOGGLE |
| | SCOPE | | | | |
| SCOPE | SAVE/ RECALL | Recall Saved Setup | Recall Factory Setup | — | |
| | | OK Recall Factory | — | | |
| | ACQUIRE | Acquire Mode | Average | <i>Set to 16</i> | |
| | TRIGGER | Trigger Mode | Normal | — | |
| MEAS | | High-Low Setup | Min-Max | — | |
| | | Select Measrmt | Ampl* | | |
| | | OK Select Measrmt | — | | |

* You may need to press Select Page to display this selection.



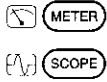

2. Connect the TekScope instrument to the leveled sine wave generator as shown below.



3. Set the leveled sine wave generator frequency to **200 MHz** if you are checking a THS730A or to **100 MHz** if you are checking a THS710A, THS720A or THS720P.
4. Set the TekScope instrument VOLTS/DIV to **500 mV/div**.
5. Set the TekScope instrument SEC/DIV to **10 ns/div**.
6. Set the leveled sine wave generator output level to approximately **50 mV_{p-p}** so that the measured amplitude is approximately **500 mV**. (The measured amplitude can fluctuate around 500 mV.)
7. Press **SET LEVEL TO 50%**. Adjust **TRIGGER LEVEL** as necessary and then check that triggering is stable.
8. Change the TekScope instrument setup using the following steps:

| | | | |
|--|---|---|---|
|  METER SCOPE |  |  |  |
| SCOPE | TRIGGER | Trigger Slope | \ (falling edge) |

9. Press **SET LEVEL TO 50%**. Adjust **TRIGGER LEVEL** as necessary and then check that triggering is stable.
10. Change the TekScope instrument setup using the following steps:

| | | | |
|--|---|---|---|
|  METER SCOPE |  |  |  |
| SCOPE | TRIGGER | Trigger Slope | / (rising edge) |

11. Proceed to the next test to check the channel 2 edge trigger sensitivity.



Check Channel 2 Edge Trigger Sensitivity

1. First check the channel 1 edge trigger sensitivity using the previous test. Then, perform these additional steps to check the channel 2 edge trigger sensitivity.



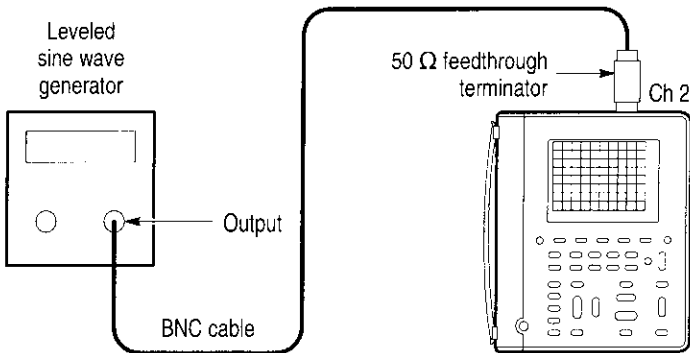

| | | | |
|----------------|--------------|-------------------|---------|
| METER SCOPE | | | |
| SCOPE | CH 1 | — | — |
| | WAVEFORM OFF | | |
| | CH 2 | | |
| | TRIGGER | Trigger Source | Ch2 |
| | MEAS | High-Low Setup | Min-Max |
| | | Select Measrmt | Ampl* |
| | | OK Select Measrmt | — |

* You may need to press Select Page to display this selection.

2. Connect the TekScope instrument to the leveled sine wave generator as shown below.



3. Set the leveled sine wave generator frequency to **200 MHz** if you are checking a THS730A or to **100 MHz** if you are checking a THS710A, THS720A or THS720P.
4. Set the TekScope instrument VOLTS/DIV to **500 mV/div**.
5. Set the TekScope instrument SEC/DIV to **10 ns/div**.
6. Set the leveled sine wave generator output level to approximately **50 mV_{p-p}** so that the measured amplitude is approximately **500 mV**. (The measured amplitude can fluctuate around 500 mV.)
7. Press **SET LEVEL TO 50%**. Adjust **TRIGGER LEVEL** as necessary and then check that triggering is stable.
8. Change the TekScope instrument setup using the following steps:





| | | | |
|---|---|---|---|
|  |  |  |  |
| SCOPE | TRIGGER | Trigger Slope | \ (falling edge) |

9. Press **SET LEVEL TO 50%**. Adjust **TRIGGER LEVEL** as necessary and then check that triggering is stable.



Check DC Voltage Accuracy

1. Set the DC voltage source output level to **0 V**.
2. Set up the TekScope instrument using the following steps:

| | | | |
|--|---|---|---|
|  METER  SCOPE |  |  |  |
| METER | — | VDC | — |

3. Connect the TekScope instrument to the DC voltage source as shown below.

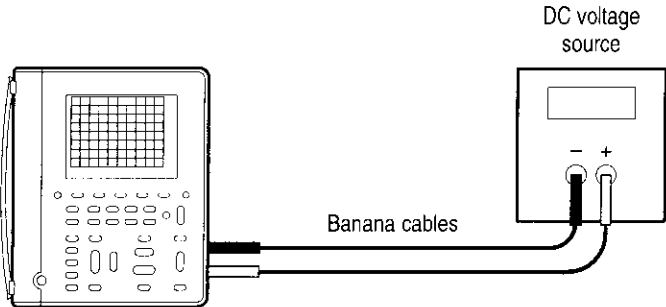

- For each range, set the DC voltage source output to the level listed below, and then compare the meter reading to the accuracy limits.





| Range | DC Voltage Source Output Level | Accuracy Limits |
|--------|--------------------------------|----------------------|
| 400 mV | 60 mV | 59.2 mV to 60.8 mV |
| 400 mV | 360 mV | 357.7 mV to 362.3 mV |
| 4 V | 3.6 V | 3.577 V to 3.623 V |
| 40 V | 36 V | 35.77 V to 36.23 V |
| 400 V | 360 V | 357.7 V to 362.3 V |
| 880 V | 792 V | 783 V to 801 V |

- Set the DC voltage source output level to **0 V**.



Check AC Voltage Accuracy

1. Set the AC voltage source output level to **0 V**.
2. Set up the TekScope instrument using the following steps:

| | | | |
|--|---|---|---|
|  METER  SCOPE |  |  |  |
| METER | — | VAC | — |

3. Connect the TekScope instrument to the AC voltage source as shown below.

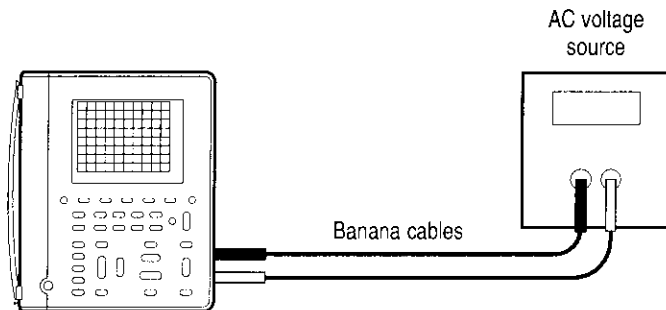

4. Set the AC voltage source output frequency to **500 Hz**.
5. For each range, set the AC voltage source output to the level listed below, and then compare the meter reading to the accuracy limits.





| Range | AC Voltage Source Output Level | Accuracy Limits |
|--------------|---------------------------------------|------------------------|
| 400 mV | 360 mV | 352.3 mV to 367.7 mV |
| 4 V | 600 mV | 0.583 V to 0.617 V |
| 4 V | 3.6 V | 3.523 V to 3.677 V |
| 40 V | 36 V | 35.23 V to 36.77 V |
| 400 V | 360 V | 352.3 V to 367.7 V |
| 640 V | 576 V | 559 V to 593 V |

6. Set the AC voltage source output level to **0 V**.



Check Resistance Accuracy

1. Set up the TekScope instrument using the following steps:

| | | | |
|--|---|---|---|
|  METER  SCOPE |  |  |  |
| METER | — | Ω | — |

2. Connect the TekScope instrument to the resistance standard as shown below.

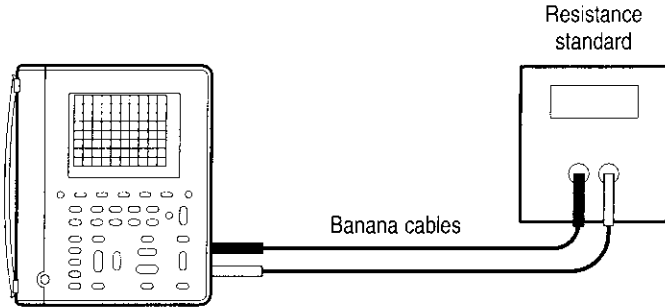

3. For each range, set the resistance standard to the resistance listed below, and then compare the meter reading to the accuracy limits.

| Range | Resistance Standard Setting | Accuracy Limits |
|-----------------|-----------------------------|--------------------------------------|
| 400 Ω | 360 Ω | 358.0 Ω to 362.0 Ω |
| 4 k Ω | 3.6 k Ω | 3.580 k Ω to 3.620 k Ω |
| 40 k Ω | 6 k Ω | 5.95 k Ω to 6.05 k Ω |
| 40 k Ω | 36 k Ω | 35.80 k Ω to 36.20 k Ω |
| 400 k Ω | 360 k Ω | 358.0 k Ω to 362.0 k Ω |
| 4 M Ω | 3.6 M Ω | 3.580 M Ω to 3.620 M Ω |
| 40 M Ω * | 36 M Ω * | 35.23 M Ω to 36.77 M Ω |

* These limits apply only when the relative humidity is $\leq 60\%$.

This completes the performance verification procedure.

Appendix E: General Care and Cleaning

General Care

Protect the TekScope instrument from adverse weather conditions. The instrument is not waterproof.

Do not store or leave the instrument where the LCD display will be exposed to direct sunlight for long periods of time.



CAUTION. To avoid damage to the TekScope instrument, do not expose it to sprays, liquids, or solvents.

Cleaning

Inspect the TekScope instrument as often as operating conditions require. To clean the instrument exterior, perform the following steps:

1. Remove loose dust on the outside of the instrument with a lint-free cloth. Use care to avoid scratching the clear plastic display filter.
2. Use a soft cloth or paper towel dampened with water to clean the instrument. You can use a 75% isopropyl alcohol solution for more efficient cleaning.



CAUTION. To avoid damage to the surface of the TekScope instrument, do not use any abrasive or chemical cleaning agents.



Glossary and Index



Glossary

+/- Rocker

The general-purpose rocker button on the front panel that you can use to set parameters. The specific parameter assigned to the +/- rocker depends on other selections.

AC Coupling

A mode that blocks the DC component of a signal but passes the dynamic (AC) component of the signal. Useful for observing an AC signal that is normally riding on a DC signal.

Acquisition

The process of sampling signals from input channels, digitizing the samples, processing the results into data points, and assembling the data points into a waveform record. The waveform record is stored in memory.

Active Cursor

The cursor that moves when you adjust the +/- rocker. The @ readout on the display shows the position of the active cursor.

Aliasing

A false representation of a signal due to insufficient sampling of high frequencies or fast transitions. A condition that occurs when an oscilloscope digitizes at an effective sampling rate that is too slow to reproduce the input signal. The waveform displayed on the oscilloscope may have a lower frequency than the actual input signal.

Attenuation

The degree the amplitude of a signal is reduced when it passes through an attenuating device such as a probe or attenuator (the ratio of the input measure to the output measure). For example, a 10X probe attenuates, or reduces, the input voltage of a signal by a factor of 10.

Auto Trigger Mode

A trigger mode that causes the oscilloscope to automatically acquire if it does not detect a triggerable event.

Autorange

A DMM feature that automatically sets the range to the optimum setting to measure an input signal. Also, an oscilloscope feature that automatically produces a stable waveform of usable size. In both cases, autorange continues to change the instrument settings to track additional signal changes.

Average Acquisition Mode

A mode in which the oscilloscope acquires and displays a waveform that is the averaged result of several acquisitions. This reduces the apparent noise. The oscilloscope acquires data as in the sample mode and then averages it according to a specified number of averages.

Backlight

The illumination behind the liquid-crystal display.

Bezel Buttons

The row of buttons below the display that selects items in the menus.

Common Lead

The meter lead attached to the reference voltage in a measurement application. Because of the isolated channels, the meter common lead and the scope reference leads do not have to be connected to the same reference voltage.

Continuity

A test to verify electrical conductivity from one point to another.

Cursors

Paired markers that you can use to make measurements between two waveform locations. The oscilloscope displays the values (expressed in volts, time, or degrees) of the position of the active cursor and the distance between the two cursors.

DC Coupling

A mode that passes both AC and DC signal components to the circuit. Available for both the trigger system and the vertical system.

Digital Real Time Digitizing

A digitizing technique that samples the input signal with a sample frequency of four to five times the oscilloscope bandwidth. Combined with $(\sin x)/x$ interpolation, all frequency components of the input up to the bandwidth are accurately displayed.

Digitizing

The process of converting a continuous analog signal such as a waveform to a set of discrete numbers representing the amplitude of the signal at specific points in time.

Diode Test

A test to verify polarity and measure the forward voltage drop of a semiconductor junction.

Displacement Power Factor (DPF)

Cosine of the phase angle between fundamental components of the voltage and current waveforms.

Display

The word used to refer to the screen or the LCD (liquid crystal display).

Edge Trigger

Triggering that occurs when the oscilloscope detects the source passing through a specified voltage level in a specified direction (the trigger slope).

Envelope Acquisition Mode

A mode in which the oscilloscope acquires and displays a waveform that shows the variation extremes of several acquisitions.

External Trigger

Triggering that occurs when the oscilloscope detects the external input signal passing through a specified voltage level in a specified direction (the trigger slope).

Floating Measurements

Voltage measurements where the reference voltage is not earth ground. The two oscilloscope inputs and the DMM input are capable of taking independent floating measurements.

Ground (GND) Coupling

Coupling option that disconnects the input signal from the vertical system.

Hard Copy

An electronic copy of the display in a format useable by a printer or plotter.

Harmonics

Voltage or current waveforms having frequencies that are integer multiples of the base (fundamental) frequency. A periodic waveform can be described as the sum of its fundamental frequency and the harmonics.

Holdoff

A specified amount of time that must elapse after a trigger signal before the trigger circuit will accept another trigger signal. Holdoff helps ensure a stable display.

Horizontal Bar Cursors

The two horizontal bars that you position to measure the voltage parameters of a waveform. The oscilloscope displays the value of the active (moveable) cursor with respect to ground and the voltage value between the bars.

Isolated Channels

The architecture of the oscilloscope and DMM inputs that allow independent floating measurements. Each input can have a different reference voltage.

Menu

A set of labels shown in the display to identify the functions of the bezel buttons. The specific menu contents depend on the menu button you press.

Motor Trigger

Triggering on the rising or falling edge of a bipolar, motordrive waveform.

Normal Trigger Mode

A mode where the oscilloscope does not acquire a waveform record unless a valid trigger event occurs. It waits for a valid trigger event before acquiring waveform data.

Paired Cursors

Two cross-shaped cursors that automatically track the vertical values of a waveform when you adjust their horizontal positions. The oscilloscope displays the voltage value and time value between the paired cursors.

Pixel

A visible point on the display. The display is 320 pixels wide by 240 pixels high.

Pop-Up Menu

A submenu of a menu. Pop-up menus temporarily occupy part of the waveform display area and present choices associated with the menu item selected. You can cycle through the options in a pop-up menu by repeatedly pressing the menu button underneath the pop-up.

Power Factor (PF)

The ratio of true power (watts) to apparent power (volt-amperes).

Pretrigger

The specified portion of the waveform record that contains data acquired before the trigger event.

Pulse Trigger

Triggering on events that you can qualify by time. The oscilloscope triggers when an incoming pulse width meets time criteria you have defined.

Record Length

The specified number of samples in a waveform.

Reference Lead

The oscilloscope lead attached to the reference voltage in a measurement application. Because of the isolated channels, the meter common lead and the scope reference leads do not have to be connected to the same reference voltage.

Reference Waveform

A saved waveform selected for display. You can display two reference waveforms as Ref A and Ref B.

Rocker

A two-position button on the front panel used to control functions such as volts/division and trigger level.

Roll Mode

An acquisition mode useful at slow horizontal scale settings. Roll mode allows you to view the waveform as it is acquired point-by-point. The waveform appears to roll across the display.

RS-232

The serial communication port used to connect to a hard-copy device, computer, controller, or terminal.

Sample Acquisition Mode

A mode in which the oscilloscope creates a record point by saving the first sample during each acquisition interval. This is the default mode of the acquisition system.

Sample Interval

The time interval between successive samples in a time base. For real-time digitizers, the sample interval is the reciprocal of the sample rate.

Sampling

The process of capturing an analog input, such as a voltage, at a discrete point in time and holding it constant so that it can be quantized.

Selected Waveform

The waveform on which all measurements are performed and which is affected by vertical position and scale adjustments.

Signal Path Compensation (SPC)

The ability of the oscilloscope to minimize the electrical offsets in the vertical, horizontal, and trigger amplifiers caused by ambient temperature changes and component aging. You should run SPC when the ambient temperature varies more than 5° C from the last SPC or before performing critical measurements.

Standby (STBY)

The off-like state when the instrument is not in use. Some circuits are active even while the instrument is in the standby state.

Tek Secure

A feature that erases all waveform and setup memory locations (setup memories are replaced with the factory setup). Then it checks each location to verify erasure. This feature is useful where the oscilloscope is used to gather security-sensitive data.

Time Base

The set of parameters that let you define the time and horizontal axis attributes of a waveform record. The time base determines when and how long to acquire record points.

Total Harmonic Distortion (THD)

The ratio of the waveform harmonic content to the RMS of either the fundamental or the input signal, expressed as a percent.

Vertical Bar Cursors

The two vertical bars you position to measure the time parameter of a waveform record. The oscilloscope displays the value of the active (moveable) cursor with respect to trigger and the time value between the bars.

Video Trigger

Triggering on the sync pulse of a composite video signal.

XY Format

A display format that compares the voltage level of two waveform records point by point. It is useful for studying phase relationships between two waveforms.

YT Format

The conventional oscilloscope display format. It shows the voltage of a waveform record (on the vertical axis) as it varies over time (on the horizontal axis).

Index

A

- accessories, C-1
- ACQUIRE button, 2-4, 3-3
- acquisition
 - modes, 3-3
 - status, 3-38, 3-47
- amplitude measurement, 3-33
- applications
 - analyzing serial data communication link, 2-30
 - detecting glitches, 2-26
 - detecting missing power cycle, 2-42
 - displaying unknown signal, 2-16
 - measuring continuity, 2-19
 - measuring diode junctions, 2-19
 - measuring frequency, 2-20
 - measuring harmonic current, 2-44
 - measuring motor startup current, 2-46
 - measuring power, 2-38
 - measuring propagation delay, 2-22
 - measuring resistance, 2-18
 - monitoring power quality, 2-40
 - testing switching transistor, 2-36
 - triggering on external signal, 2-28
 - triggering on missing pulse, 2-24
 - triggering on motor drive waveform, 2-50
 - triggering on motor RPM, 2-48
 - triggering on video signal, 2-32
- automatic measurements, 3-31

AUTORANGE

- button, 2-6
 - turning off, 3-10
 - turning on, 3-8
- average statistic, 3-36
- averaging, 3-3

B

- backlight, 3-63
- bandwidth limit, 3-67
- bar graph, 3-42
- battery
 - capacity, 1-6
 - charging, 1-6
 - external charger, C-3
 - low battery indicator, 1-6
 - replacing, 1-5
- beep, 3-36
- burst width measurement, 3-33
- buttons, using, 2-1, 2-6

C

- cleaning, E-1
- CLEAR MENU button, 2-7
- connectors, 1-4
- continuity, 2-19
- contrast, display, 3-13
- conventions, vi
- coupling
 - trigger, 3-54
 - vertical, 3-67

- current probe
 - description, C-4
 - scale factor, 3-67
 - using, 2-38, 2-48, 3-15
- CURSOR button, 2-5, 3-11
- cursors
 - application example, 2-22
 - readouts, 3-12, 3-39
 - using, 3-11
- cycle mean measurement, 3-33
- cycle RMS measurement, 3-33

D

- data logger
 - application example, 2-40
 - display, 2-7, 3-40
 - position, 3-41, 3-71
 - saving and recalling, 3-45
 - scroll speed, 3-30
 - zoom, 3-41, 3-71
- dB and dBm scale, 3-71
- delayed time base, 3-29
- $\Delta 0$ statistic, 3-36
- diagnostics, 3-65
- diode test, 2-19
- DISPLAY button, 2-5, 3-13
- display contents
 - meter mode, 3-37
 - scope mode, 3-46
- dots, 3-13

E

- edge trigger, how to use, 3-54
- envelope, 3-3
- external power
 - connector location, 1-4
 - using, 1-7
- external trigger, how to use, 3-54

F

- factory setup
 - detailed description, B-1
 - recalling, 3-44
- fall time measurement, 3-33
- features
 - automatic measurements, 2-20
 - cursors, 2-22
 - data logger, 2-40
 - dot accumulate, 2-32
 - isolated channels, 2-12, 2-36
 - overview, 1-1
 - pulse trigger, 2-24, 2-26, 2-48
 - triggers, 3-52
 - waveform math, 2-38
- floating measurements
 - application example, 2-36
 - overview, 2-12
- frequency measurement, 3-33
- front panel, 2-1, 2-6
- functional check, 1-9

G

- graticule, 3-13

H

- HARD COPY button, 3-22
- harmonic distortion, calculation
 - method, 3-17, A-8
- harmonics
 - display, 3-17
 - measurements, 3-18
 - menu, 3-16
 - saving and recalling, 3-44
 - setup, 3-16
 - status line, 3-18
- high level measurement, 3-33

high voltage, warning, 2-14
HOLD button, 3-26
holdoff, 3-55
HORIZONTAL MENU button,
2-5, 3-27

I

input protection, A-2, A-10, A-11,
A-12
inputs, 1-4
intensity, display, 3-13
isolated channels
application example, 2-36
description, 2-12

L

line trigger, 2-29
losing saved information, 1-5
low battery indicator, 1-6

M

MAG button, 3-28
manual conventions, vi
math waveform
allowed units, 3-68
application example, 2-38
functions, 3-68
max measurement, 3-33
max statistic, 3-36, 3-42
max-min statistic, 3-36
mean measurement, 3-33
MEAS button, 2-5, 3-31

measurement applications
continuity, 2-19
data logger, 2-40
diode junction, 2-19
floating, 2-12, 2-36
frequency, 2-20
motor current, 2-48
phase, 3-12
power, 2-38
propagation delay, 2-22
resistance, 2-18
measurement definitions
harmonics, 3-18, A-8
meter mode, 3-36
power measurements, 3-20, A-9
scope mode, 3-33
measurement qualifier, 3-51
menus
acquire, 2-4, 3-3
cursor, 2-5, 3-11
display, 2-5, 3-13
horizontal, 2-5, 3-27
how to use, 2-1
measure, 2-5, 3-31
meter, 3-37
overview, 2-4
save/recall, 2-4, 3-43
trigger, 2-5, 3-52
utility, 2-5, 3-60
vertical, 2-5, 3-66
meter
deluxe lead set, C-3
lead set, C-1
noise reject, 3-71
range, 3-41
METER button, 3-37

- meter mode
 - features, 1–3
 - how to use, 2–9
- min measurement, 3–33
- min statistic, 3–36, 3–42
- motor trigger, how to use, 3–59

N

- negative duty cycle measurement, 3–34
- negative overshoot measurement, 3–34
- negative width measurement, 3–34
- nonvolatile memory
 - saving information into, 3–44
 - when replacing battery, 1–5

O

- ON/STBY
 - button, 2–7
 - using, 1–5, 1–6
- overrange indicator, 3–38

P

- P5102
 - compensating, 2–10
 - description, C–1, C–3
 - specifications, A–11
- P6117
 - compensating, 2–10
 - description, C–1
 - specifications, A–10
- peak detect, 3–3
- peak-to-peak measurement, 3–34

- performance verification, D–1
- period measurement, 3–34
- phase measurement, 3–12
- position
 - data logger, 3–41
 - horizontal, 3–28
 - of reference waveforms, 3–69
 - trigger, 3–29
 - vertical, 3–66
- positive duty cycle measurement, 3–34
- positive overshoot measurement, 3–34
- positive width measurement, 3–34
- power measurements, 3–20
 - saving and recalling, 3–44
- pretrigger, 3–29
- printing, 3–22
- probe compensator
 - location, 1–4
 - using, 2–10
- probe descriptions
 - A605, A610, C–5
 - A621, A622, C–4
 - P5102, C–1, C–3
 - P6117, C–1
 - P6408, C–5
- product description
 - accessories, C–1
 - general, 1–1
 - meter, 1–3
 - oscilloscope, 1–2
 - specifications, A–1
- pulse trigger
 - application examples, 2–24, 2–26, 2–48
 - how to use, 3–56

R

- readouts
 - cursors, 3–12
 - DMM reading, 3–39, 3–48
 - measurements, 3–18, 3–51
 - power measurements, 3–20
 - time base, 3–50
 - trigger, 3–50
 - waveform, 3–19, 3–49
- reference lead, 2–14
- reference waveforms, 3–69
- Rel Δ , 3–7
- reset
 - data logger, 3–40
 - statistics, 3–36
- resistance, 2–18
- rise time measurement, 3–34
- RMS measurement, 3–34
- roll mode, 3–28
- RS-232
 - adapters, C–2
 - cable, 3–24, C–2
 - hard copy, 3–22
 - pinout, A–16
 - port location, 1–4
 - setting up, 3–62
 - troubleshooting, 3–62
- RUN/STOP button, 3–26

S

- sample, 3–3
- SAVE/RECALL button, 2–4, 3–43
- saved information, to prevent loss, 1–5
- SCOPE button, 3–46

- scope mode
 - features, 1–2
 - how to use, 2–8
- SEC/DIV rocker
 - meter mode, 3–30
 - scope mode, 3–28
- selected waveform
 - how to select, 3–66
 - indicator, 3–48
- self test, 3–65
- SET LEVEL TO 50% button, 2–7
- setups
 - factory setup description, B–1
 - saving and recalling, 3–43
- signal path compensation, 2–11, 3–64
- single acquisition sequence, 3–6, 3–26
- specifications, A–1
- standby timeout, 3–63
- statistics
 - readout location, 3–39
 - resetting, 3–26
 - selecting, 3–35
- status, 3–47
- STBY. *See* ON/STBY

T

- T symbol, 3–27, 3–29
- Tek Secure, 3–61
- THD, calculation method, 3–17, A–8
- tilt stand, 1–8
- time base, 3–29
- time-out, 3–63
- TOGGLE button, 3–11

TRIGGER MENU button, 2–5,
3–52

trigger position, 3–29

trigger status, 3–47

triggering

- Auto mode, 3–54
- edge trigger, 3–54
- external trigger, 3–54
- motor trigger, 3–59
- Normal mode, 3–54
- on AC line, 2–29
- on glitches, 2–27
- on missing pulse, 2–24
- on specific frequency, 2–48
- on video signal, 2–32
- pulse trigger, 3–56
- readout, 3–50
- setting coupling, 3–54
- setting holdoff, 3–55
- setting level, 3–52
- setting pretrigger, 3–29
- setting slope, 3–54
- video trigger, 3–58

U

UTILITY button, 2–5, 3–60

V

vectors, 3–13

VERTICAL MENU button, 2–5,
3–66

video trigger

- application examples, 2–32
- how to use, 3–58
- sync pulses, 3–58

VOLTS/DIV rocker

- channels, 3–67
- math waveform, 3–68
- meter mode, 3–41

W

WAVEFORM OFF button, 3–66

waveforms, saving and recalling,
3–43

X

XY display, 3–14

Z

zoom, 3–41, 3–71

- turning off, 3–10
- turning on, 3–8